

We touch your **electricity** everyday!

WiNtrip

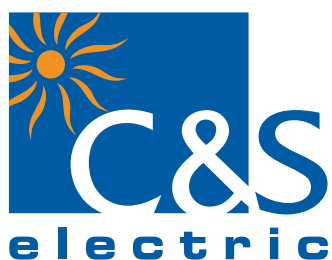

**Residual
Current Circuit Breaker**

C&S Electric Ltd. is amongst the leading suppliers of electrical equipment in India and is India's largest exporter of industrial switchgear. It's wide range of electrical and electronic products find application in power generation, distribution, control, protection and final consumption.

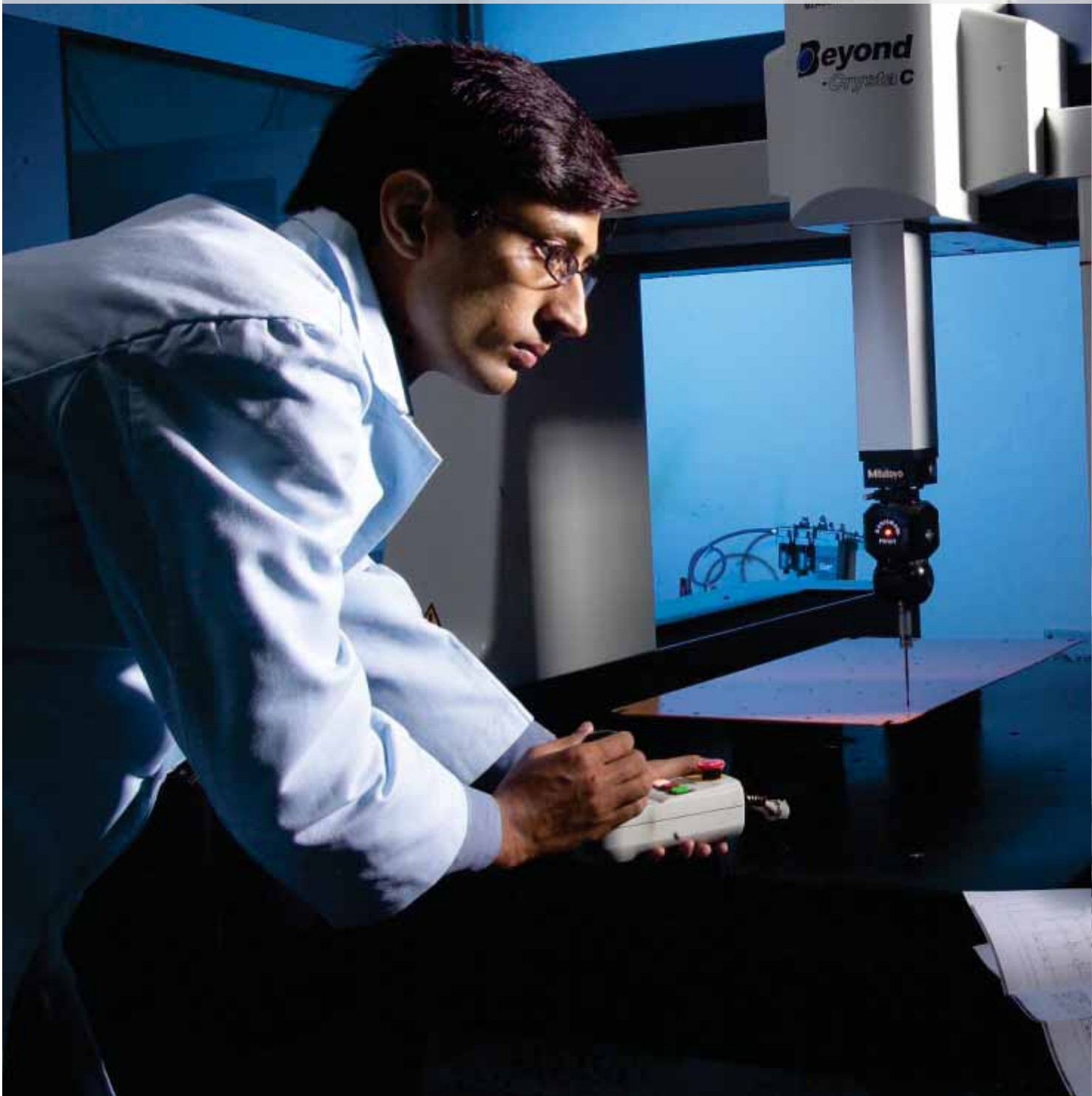

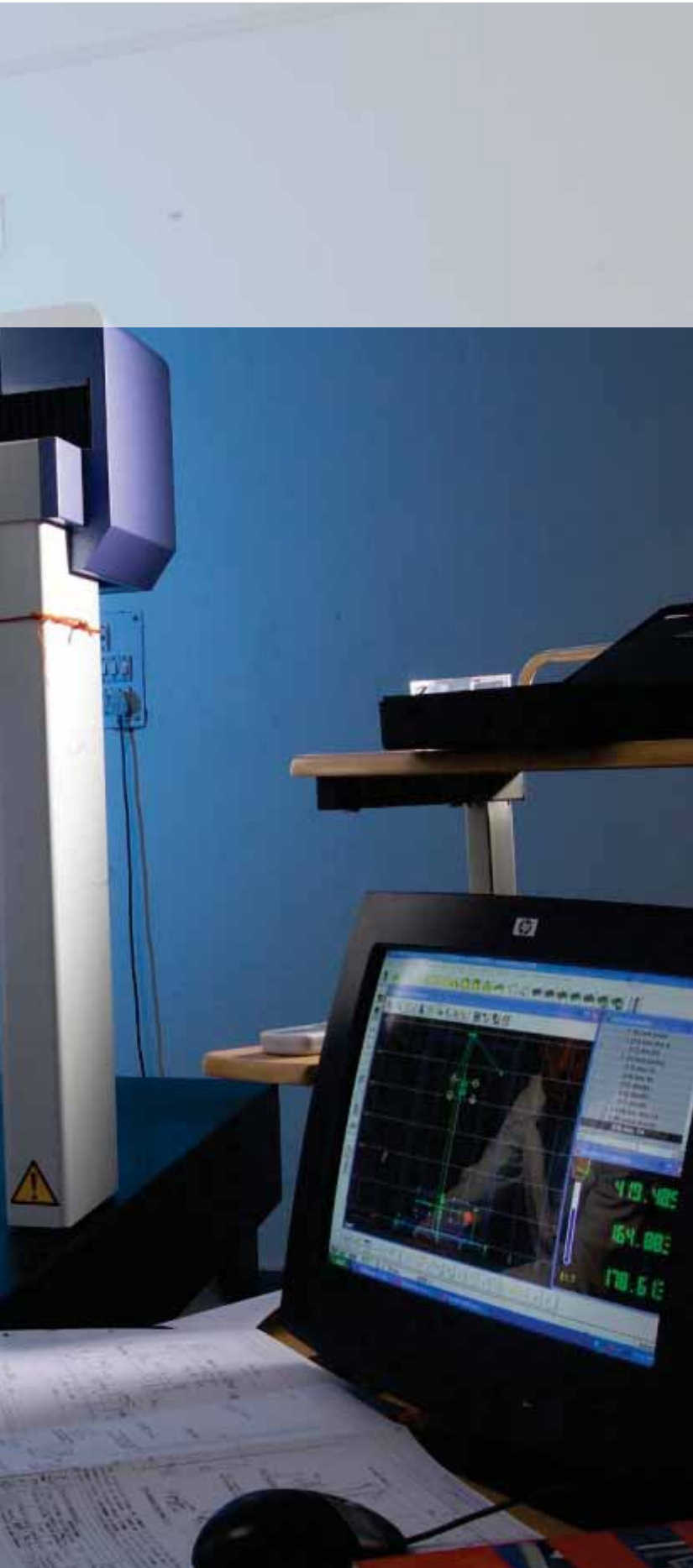

CONTENTS

Introduction	5
Highlights	6
Technical Data	7
Features - Performance	8
Product Reference - RCCB	10
Dimensions	11



WiNtrip

Residual Current Circuit Breaker



From Bungalows to High Risers, from Trade Centres to Hotels, from Clinics to Hospitals, from escalators to elevators electricity is the foremost requirement. Electricity has become an integral part of our life so common to our daily requirements that we forget its intricacies and hazardous behaviour.





Day after day we come across many un to do events hampering human lives due to negligent usage of electricity. Even large number of Industrial and Domestic fire are attributed to and caused by electricity.

Faulty insulated equipments or wrong usage of electrical devices cause current to flow through insulation to the earth. This is leakage current. This current poses two severe risk factors which are

- Fire Risk
- Electrocutation Risk

Residual Current Circuit Breaker provides the function of isolation switching and earth leakage protection of electrical circuits. It also provides the indirect protection of the human body against the dangerous effects of electric current. It is also a protective device against fire caused by the electrical circuit fault.

Physiological Effect of Electric Current on Human Body

- | | | |
|-----------|---|--|
| 500 mA |  | Immediate cardiac arrest resulting in death |
| 70-100 mA |  | Cardiac fibrillation; the heart begins to vibrate and and no longer beats at a steady rate. This situation is dangerous since it is irreversible |
| 20-30 mA |  | Muscle contraction can cause respiratory paralysis |
| 10 mA |  | Muscle contraction: the person remains "stuck" to the conductor |
| 1-10 mA |  | Prickling sensations |

As per Indian Electricity Rules 1956 at all installations with load above 5 KW use of RCCB is compulsory

IS/IEC 12640-1:2008
CML-3148552



RoHS
Compliant



Highlights



A state-of-the-art product fit for Industrial, Residential and Commercial applications. It is one piece residual current circuit breaker which is used both for control and isolation of electrical circuits. It provides total protection to all living beings against direct and indirect contact as well as to installations, big or small, against insulation faults. **Human life is valueless and WiNtrip RCCB is the solution provider for safeguarding it.**

Majority of mishaps occur due to current leakage consequently leading to fire. WiNtrip RCCB of the required rating instantly detects this leakage and terminates the supply reducing the risk of any kind of fire. The range is available in AC Residual Tripping Characteristics in 2 & 4 Pole configurations in 10, 16, 20, 25, 32, 40, 63, 80 & 100Amps in 30, 100 & 300mA sensitivity.

- Provides protection against earth fault/leakage current and also fulfill the function of isolation.
- Automatically measures and disconnect the circuit when earth fault/leakage current occurs and exceeds the rated sensitivity.
- High short-circuit current withstand capacity - 6kA
- Dual termination possible for cable and comb type busbar connection
- Equipped with finger protected connection terminals (IP20)
- Fire resistant plastic parts to withstand abnormal heating and strong impact
- Independent of power supply and line voltage. Also free from external voltage fluctuation.
- Incorporates a filtering device for prevention of nuisance tripping due to transient voltage
- Easy padlocking facility.

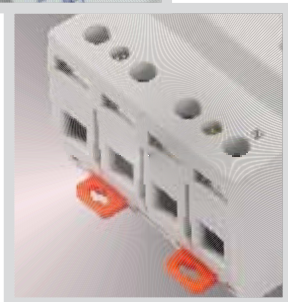
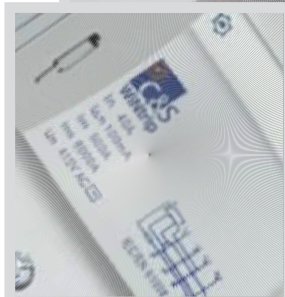

Technical Data - Characteristics

Standards			IS 12640-1:2008	
Residual tripping characteristics			AC	
Tripping time at $I_{\Delta n}$	Instantaneous	ms	<40	
	Selective	ms	>150	
Rated current			A	
Rated residual current $I_{\Delta n}$			mA	
Calibration temperature			°C	
Number of poles versus modules			1	
Rated voltage U_n	2P AC	V	240	
	4P AC	V	415	
Frequency			Hz	
Maximum service voltage U_{bmax}			V	
Minimum service voltage U_{bmin}			V	
Power supply			Top / Bottom	
Rated making and breaking capacity (I_m)			A	
Residual making and breaking capacity ($I_{\Delta m}$)			A	
Conditional short-circuit capacity (I_{nc})			A	
Conditional residual short-circuit capacity ($I_{\Delta c}$)			A	
Grid distance (safety distance between two devices)			mm	
Isolator application			yes	
Insulation degree	Insulation voltage	V (DC)	660	
	Shock voltage (1.2/50 μ s)	kV	6	
	Insulation resistance	m Ω	1000	
	Dielectric strength	V	2500	
Shock resistance (in x, y, z direction) (EN / IEC 60077/16.3)			40g	
Vibration resistance (in x, y, z direction; EN / IEC 60068-2-6)			1.5g	
Endurance	electrical at U_n, I_n			10000
	mechanical at U_n, I_n			20000
Protection degree (outside/inside electrical enclosure) with door			IP20 / IP40	
Self extinguish degree (according to UI94)			V2	
Tropicalisation (acc. to EN/IEC 60068-2, DIN 40046)			°C/RH	
Pollution degree (acc. EN/IEC 60947-1)			+55 / 95%	
Pollution degree (acc. EN/IEC 60947-1)			3	
Operating temperature			AC (-5 ~ +60)	
Storage temperature			°C	
Terminals capacity	Rigid cable min/max (top)	mm ²	1.5/25	
	Flexible cable min*/max (top)	mm ²	1.5/25	
	Rigid cable min/max (bottom)	mm ²	1.5/25	
	Flexible cable min*/max (bottom)	mm ²	1.5/25	
	(*Flexible cable 0.75/1/1.5 mm ² with cable lug)			
Busbars systems	Pin			yes
	Fork			yes
CE marking			yes	
Torque	Top / Bottom	Nm	5/5	

Features - Performance



Test Button



Rated current I_n / $I_{\Delta n}$



DIN Rail Mounting

Type AC		
Rated Current setting I_n	A	10, 16, 20, 25, 32, 40, 63, 80, 100
Residual current $I_{\Delta n}$	mA	30, 100, 300
Rated voltage AC U_n	V	2P : 240; 4P : 415
Minimum operating voltage U_{min}	V	2P : 100; 4P : 190
Mechanical/electrical endurance		20000 / 10000
Tropicalisation acc.to EN/IEC 60068-2-28/2-30 and DIN 40046		95% RH at 55 °C
Terminal capacity exible/rigid cable	mm ²	25/25
Poles		2, 4
Nuisance tripping resistance		250A 8/20us; 200A 0.5us - 100kHz
Ambient temperature	°C	-5 upto 40
Weight	g	2P- 224.5; 4P-409

Short-circuit Capacity	
Acc. to EN/IEC 61008-1	$I_m = 500A$
Making and breaking capacity	$I_{Dm} > 500A$ from 16 upto 40A $I_{Dm} = 10I_n$ from 63 upto 100A
Short-circuit capacity	$I_{nc} = 6000A$ at 240/415V Fuse 80A gG

Normal operation and mounting requirement

1. Ambient temperature $-5^{\circ}C \sim +40^{\circ}C$ •Altitude above sea level less than 2000 m.
2. Humidity not exceeding 50% at $40^{\circ}C$ and not exceeding 90% at $25^{\circ}C$.
3. Installation class II or III.
4. Pollution degree 3.
5. All equipments used should be properly earthed.
6. For right operation should ensure that the neutral conductor on the load side of the RCCB must not be linked to earth. Otherwise tripping may be impaired or nuisance tripping may occur.
7. Installation method DIN Rail mounting type.
8. Product should be installed vertically at the place where there shall be no severe impact and vibration.
9. The product is switched on when the handle is at upper position.

RCCB Tripping Cause Detection & Remedy

1. Switch OFF all the MCBs connected to the circuit downstream the RCCB.
2. Switch ON the RCCB and switch ON the MCBs one by one.
3. During switching ON of a particular circuit RCCB keeps tripping frequently.
4. In this circuit the fault persists.
5. Isolate the faulty circuit, correct the fault. Now the RCCB will not trip.

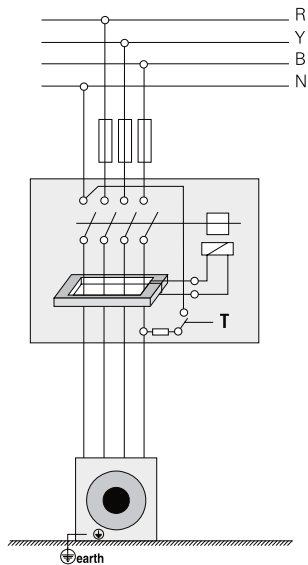

Working Principle

The RCCB works on the current balance principle. The supply conductors are passed through a toroid and form the primary windings of a current transformer. Its secondary winding is connected to a highly sensitive electromagnetic trip relay, which operates the trip mechanism.

In a healthy circuit, sum of the current in phases, is equal to the current in the neutral and the vector sum of all current is equal to zero. If there is any insulation fault in the current and leakage current flows to earth, the current do not balance and their vector sum is not equal to zero. This imbalance is detected by the core balanced current transformer, the RCCB is tripped and supply to load is interrupted.

Sensitivity Selection Criteria

Sensitivity	Application
30mA	Designed for additional protection against direct contact. The 30 mA RCCB protects against leakage currents and indirect contact with earth loop impedance up to 1667 Ohms.
100mA	Is suitable for protection against indirect contact and leakage current for larger installations. The 100 mA RCCB's operate within 30 ms, but do not provide the same level of personal protection as the 30 mA units. The 100 mA RCCB protects against leakage currents and indirect contact with earth loop impedance up to 500 ohms.
300mA	A less sensitive protection device suitable for large installations having high levels of leakage current. 300 mA RCCB's protect against leakage current and indirect contact up to 167 ohms earth loop impedance.

Current Limiting Curve

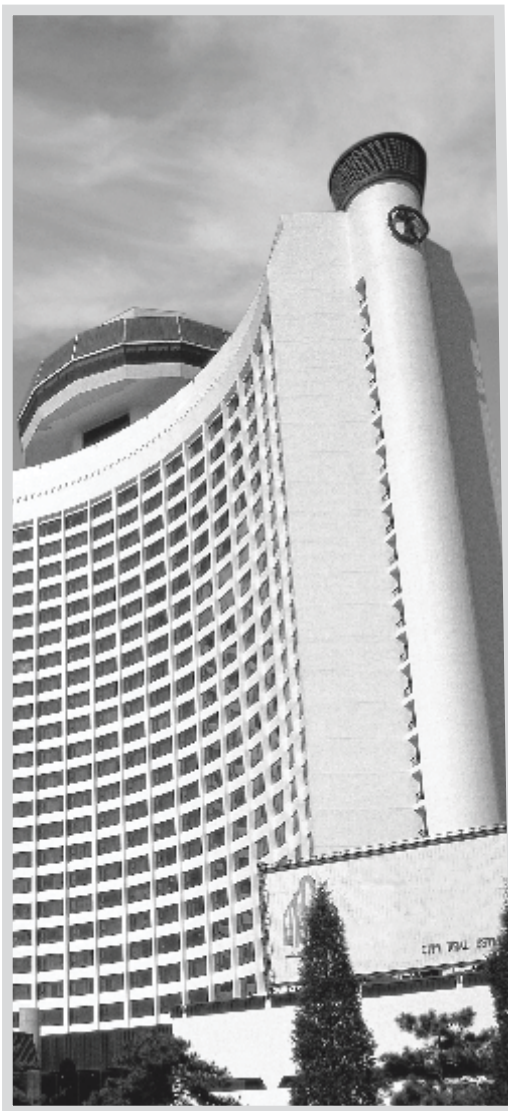
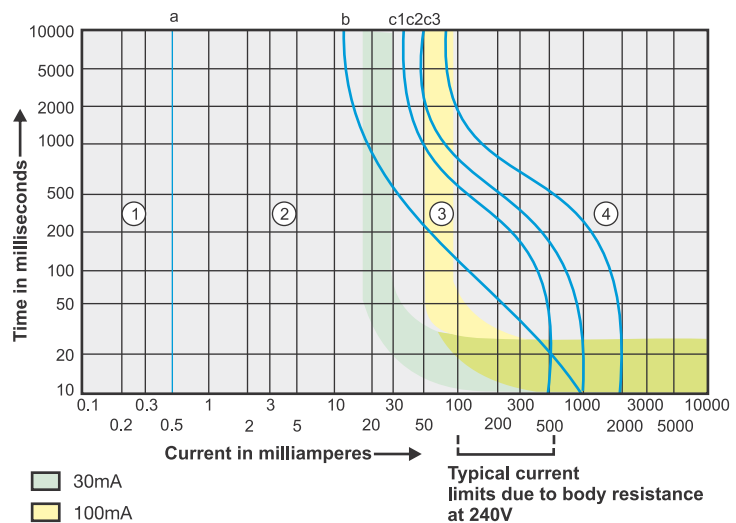

Product Reference - RCCB

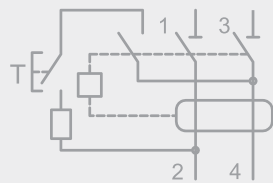

Double Pole

Wiring Diagram	Rated Current	Reference	Sensitivity
Double Pole	10	CSRB2P10A30	30
		CSRB2P10A100	100
		CSRB2P10A300	300
	16	CSRB2P16A30	30
		CSRB2P16A100	100
		CSRB2P16A300	300
	20	CSRB2P20A30	30
		CSRB2P20A100	100
		CSRB2P20A300	300
25	CSRB2P25A30	30	
	CSRB2P25A100	100	
	CSRB2P25A300	300	
32	CSRB2P32A30	30	
	CSRB2P32A100	100	
	CSRB2P32A300	300	
40	CSRB2P40A30	30	
	CSRB2P40A100	100	
	CSRB2P40A300	300	
63	CSRB2P63A30	30	
	CSRB2P63A100	100	
	CSRB2P63A300	300	
80	CSRB2P80A30	30	
	CSRB2P80A100	100	
	CSRB2P80A300	300	
100	CSRB2P100A30	30	
	CSRB2P100A100	100	
	CSRB2P100A300	300	

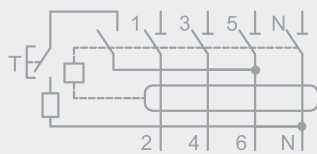

Four Pole

Four Pole	10	CSRB4P10A30	30
		CSRB4P10A100	100
		CSRB4P10A300	300
	16	CSRB4P16A30	30
		CSRB4P16A100	100
		CSRB4P16A300	300
	20	CSRB4P20A30	30
		CSRB4P20A100	100
		CSRB4P20A300	300
25	CSRB4P25A30	30	
	CSRB4P25A100	100	
	CSRB4P25A300	300	
32	CSRB4P32A30	30	
	CSRB4P32A100	100	
	CSRB4P32A300	300	
40	CSRB4P40A30	30	
	CSRB4P40A100	100	
	CSRB4P40A300	300	
63	CSRB4P63A30	30	
	CSRB4P63A100	100	
	CSRB4P63A300	300	
80	CSRB4P80A30	30	
	CSRB4P80A100	100	
	CSRB4P80A300	300	
100	CSRB4P100A30	30	
	CSRB4P100A100	100	
	CSRB4P100A300	300	

Dimensions

Double Pole

CSRB2P10A30
CSRB2P10A100
CSRB2P10A300

CSRB2P40A30
CSRB2P40A100
CSRB2P40A300

CSRB2P16A30
CSRB2P16A100
CSRB2P16A300

CSRB2P63A30
CSRB2P63A100
CSRB2P63A300

CSRB2P20A30
CSRB2P20A100
CSRB2P20A300

CSRB2P80A30
CSRB2P80A100
CSRB2P80A300

CSRB2P25A30
CSRB2P25A100
CSRB2P25A300

CSRB2P100A30
CSRB2P100A100
CSRB2P100A300

CSRB2P32A30
CSRB2P32A100
CSRB2P32A300

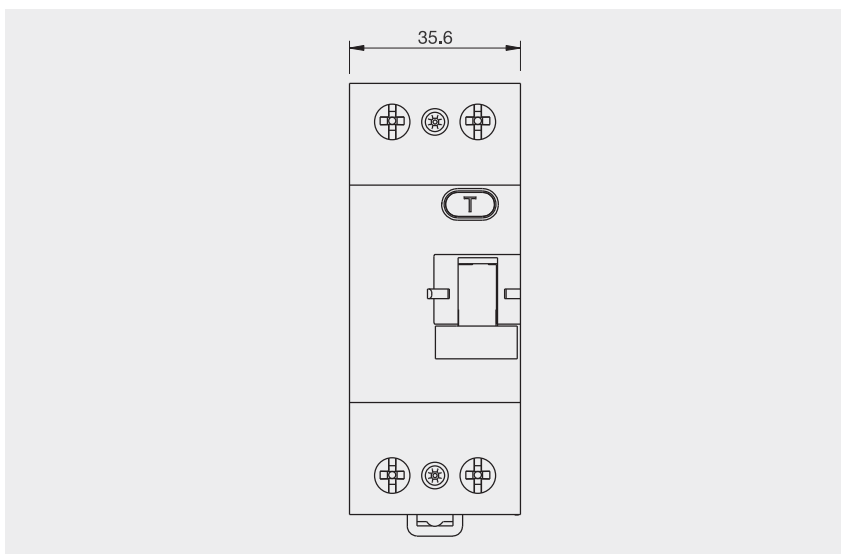

Four Pole

CSRB4P10A30
CSRB4P10A100
CSRB4P10A300

CSRB4P40A30
CSRB4P40A100
CSRB4P40A300

CSRB4P16A30
CSRB4P16A100
CSRB4P16A300

CSRB4P63A30
CSRB4P63A100
CSRB4P63A300

CSRB4P20A30
CSRB4P20A100
CSRB4P20A300

CSRB4P80A30
CSRB4P80A100
CSRB4P80A300

CSRB4P25A30
CSRB4P25A100
CSRB4P25A300

CSRB4P100A30
CSRB4P100A100
CSRB4P100A300

CSRB4P32A30
CSRB4P32A100
CSRB4P32A300

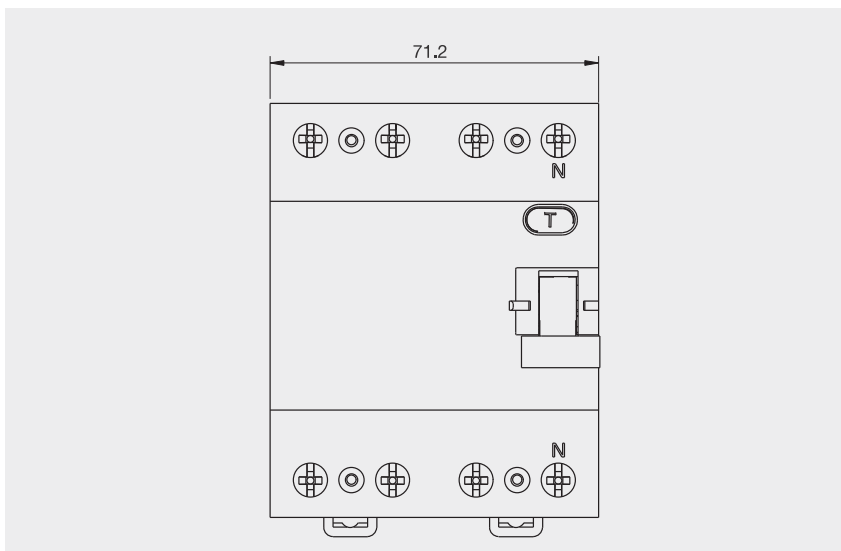

Side view - Double & Four Pole

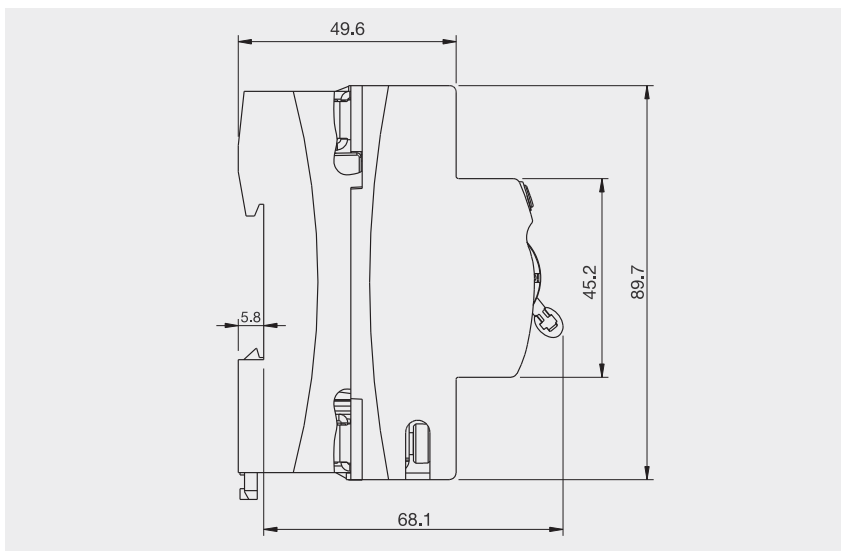

All dimensions are in mm

Residual Current Circuit Breaker

RCCB
Protects from
SHOCK



MCB
Protects from
**SHORT CIRCUIT
AND OVERLOAD**

C&S Electric Limited

Corporate Office & CMO: 222, Okhla Industrial Estate, Phase-III, New Delhi-110020 (India)

Tel.: +91-11-3384 9000-09 Fax: +91-11-2684 7342 E-mail: cmo@cselectric.co.in

International Business Division: Tel.: +91-11-3384 9000-09 Fax: +91-11-2684 7342

E-mail: exports@cselectric.co.in



RCCB 00/057 2017