

We touch your **electricity** everyday!

## CSENEX-M

Intelligent Measuring and Protection Device

CSENEX  
CSENEX  
CSENEX  
CSENEX  
Series



Catalogue

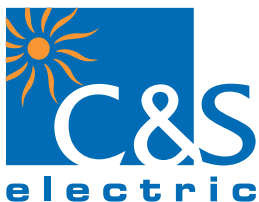

PMD Division

## CONTENTS

S.No.	Description
1.	Introduction
2.	Application
3.	Hardware
4.	Protection Features
5.	Functional Diagram
6.	Protection Functions
7.	Monitoring Functions
8.	Event Record
9.	Fault Record
10.	Human Machine Interface
11.	Communication
12.	Setting Ranges
13.	Technical Data
14.	Standards
	14.1 High Voltage Tests
	14.2 EMC Immunity Tests
	14.3 Environmental Tests
	14.4 Mechanical Tests
15.	TCS Diagram
16.	Connection Diagram
17.	Dimensional Details
18.	Ordering Information



## 1.0 Introduction

CSENEX series offers a multi functional comprehensive smart protection solution for Feeder, Generator, Motor & Transformer segment.

CSENEX family of protective relays are advance numerical relays that provide multi protection and monitoring with reliable and fast protection solutions in a single unit.

In this family of CSENEX series, the CSENEXMxxx is an motor protection solution which has fast, sensitive and secure protection for LV & MV motors, which are either operated via power contactors or power circuit breakers.

CSENEXM offers following features in a compact & smart flush mounting enclosure.

- ❖ 1A & 5A Programable rated current.
- ❖ Drawout enclosure have modular design with CT shorting
- ❖ Protection like: thermal overload, over-current, undercurrent, short circuit etc.
- ❖ Communication
- ❖ 25 Fault records
- ❖ 50 Event records
- ❖ Motor start/ Stop record
- ❖ Programmable input / Output
- ❖ Maxi-meter with time stamp.
- ❖ CSENEX-M relays are equipped with self supervision function.

## 2.0 Application

The CSENEX-M relay is the ideal answer to problems requiring more versatile or accurate protection for a motor than can be offered by standard thermal overload relay. It employs the latest micro controller techniques to provide the complete solution for the protection of medium & large sized and three phase motors with high inertia load in all type of ordinary contactors controlled or circuit breaker controlled motor drives. It handles fault condition during motor start up, normal run, idling and cooling down at standstill in, for example pump, fan, mill, crusher applications.

Uses:

- ❖ helps in extending life time of motor
- ❖ helps in optimizing motor size
- ❖ helps in planning maintenance work
- ❖ protects the drive for mechanical damage

## 3.0 Hardware

- ❖ Digital Signal Processor based numeric design
- ❖ Measures true RMS with DFT filter.
- ❖ 1A & 5A common current terminal & programmable.
- ❖ 4 Current analogue input for phase & earth fault current
- ❖ 4 Digital Outputs
- ❖ 4 Digital Inputs for protection & supervision
- ❖ 8 LEDs at pickup & trip on fault + 3 LED's with special function of 3 control keys.
- ❖ USB/RS-485 communications for automation
- ❖ 16x4 Alpha numeric LCD



(Figure-1)

## 4.0 Protection Features

- ❖ Current unbalance with DEFT & INV (46)
- ❖ Phase Over current (51)
- ❖ Thermal Over load protection (49)
- ❖ Locked rotor (50LR)
- ❖ Short circuit protection (50)
- ❖ Under current (37)
- ❖ Stall (50S)
- ❖ Earth fault (50N/51N)
- ❖ Anti-backspining protection (Start Interval)
- ❖ CBFP (50BF)
- ❖ Trip circuit supervision (74TC)
- ❖ Phase loss

## 5.0 Functional Diagram

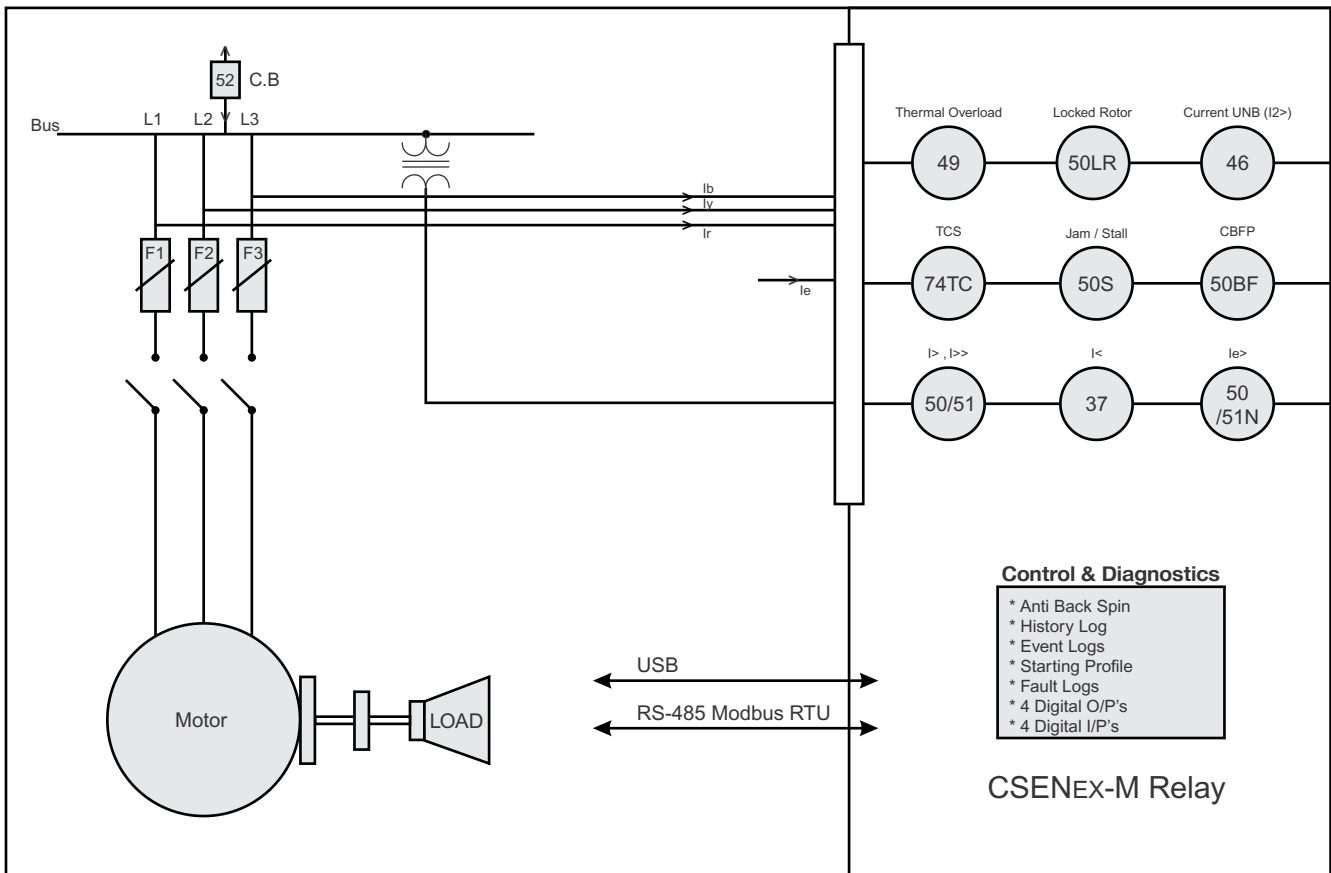

(Figure-2) CSENEX-M Functional Diagram

## 6.0 Protection Functions

### Undercurrent Protection (I<)

This protection covers the Loss of load condition like V-belt split or shaft failure or a pump running unprimed or Running dry Protection, Broken conveyer belt.

If while running condition, the phase current goes below the adjusted current level for a defined time, CSENEX-M will trip to stop the motor.

### Phase Over-current (51)

This protection gives backup protection for motor external faults. If the external faults are not cleared by the primary protections, this over current unit will actuate, otherwise the motor will be seriously damaged due to overloads. Each winding has overload as well as short-circuit protection. Refer Table – 1 for these protection settings.

### Earth Over-current (50/51N)

This is an over current function used on the current measured at the grounding of a motor in order to detect faults to earth. Each winding features has Earth low and Earth hi-set protections. Refer Table – 3 for these protection settings.

### Phase Loss or Single Phase Protection

During a phase loss, the motor winding current may increase by 150% or more. As the motor winding current increases, the winding temperature may also increase and possibly damage the winding insulation.

The quick trip time on CSENEX-M helps to prevent over-current damage to the windings

### Negative Phase Sequence (46)

Running motors at unbalance conditions results in overheating. They are often fed through fuses and may be energized with one fuse blown causing single phasing of motor the relay detects the negative phase sequence & trip according to set characteristics(DEFT/INV).

Negative Phase Sequence Equation

$$t = \frac{K1}{(I2/I2s)^2 - 1}$$

K1 : TMS for Inverse characteristics of NPS  
 t : Expected Trip Time  
 I2 : Measured negative sequence value  
 I2s : Permissible NPS value

Trip timing accuracy : ±7.5% OR ±40mSec (whichever is higher)

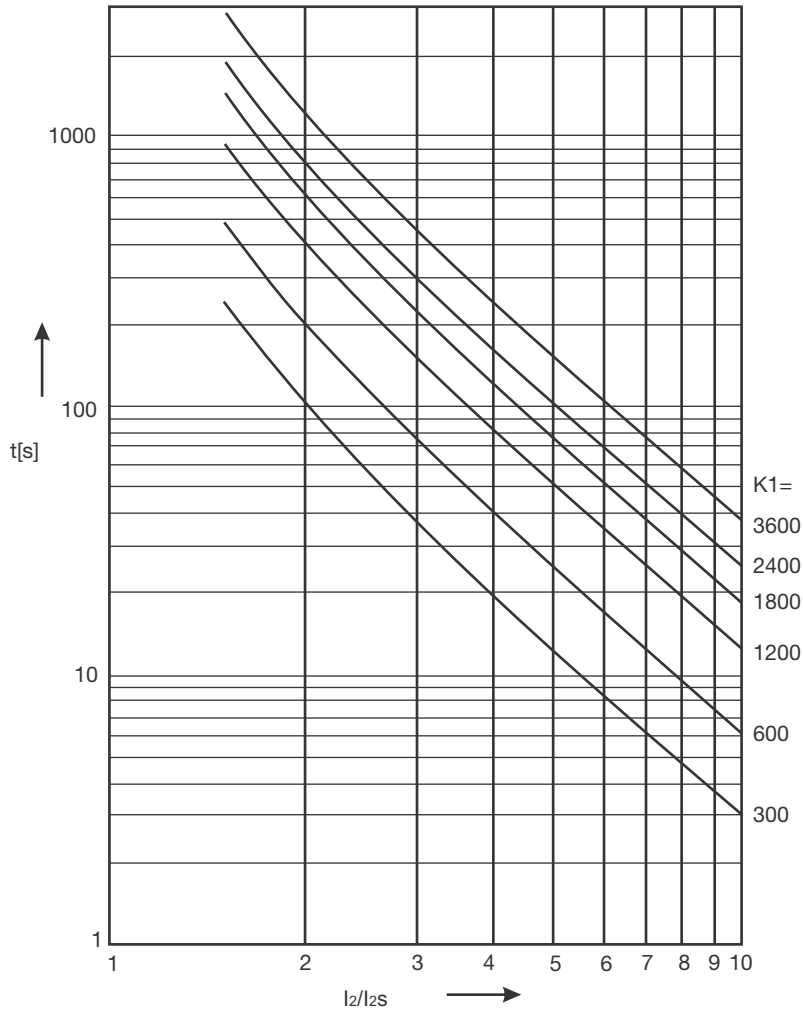

(Figure-3)

### Locked Rotor (50LR)

During motor start-up, a locked rotor is detected with the state of increased phase current above the set value for above the defined start time. The common application is on motors used on crushers, chippers, or conveyors. Motor Start-up is detected on crossing full load current when previous state was STOP under the motor startup time.

### Short Circuit Protection (I>>) (50)

The stage with definite time delay protects against phase short circuit faults, which are responsible of overheating damages.

### Thermal Overload Protection (49)

Provides reliable protection for motor starting as well as for heavy and repeated starting.

**CAUTION: \* Make sure that at the of installation of relay, motor is in complete cold state having no thermal content otherwise thermal modeling of relay will not be in synchronisation with actual thermal state of motor.**

**(Changing this, M1 model will immediately affect the thermal of motor, take caution when use this M1 setting)**

Thermal memory is saved all to selection in HMI

M1: On power Reset thermal memory becomes 0.

M2: On power Reset thermal memory starts from the same value as at the time of power off.

M3: On power Reset thermal memory subtracts for the time it is in off state & starts from the remaining value.

The formula for calculating the trip characteristics is as follows:

$$\text{Trip time (t)} = \tau \cdot \ln \left[ \frac{\left( \frac{I_2}{I_b} \right)^2 - p^2}{\left( \frac{I^2}{I_b^2} \right) - k^2} \right] \quad \text{for } p^2 < \frac{I^2}{(I_b^2)} \quad \text{and } p^2 \leq k^2$$

with  $\tau$  = thermal time constant of the object to be protected.

$I_b$  = Basic current

$I_p$  = Initial load current

$P$  = Initial load factor ( $p=0$  means cold operating component)

$k$  = constant

for thermal characteristics user has two choices

(1) Thermal based on highest measured RMS current

$$I = \sqrt{I_1^2 + I_2^2 + I_0^2}$$

OR

(2) Thermal based on positive & negative sequence measured.

$$I = \sqrt{I_1^2 + \text{Neg}_k \times I_2^2}$$

where

$I_0$  = Zero phase sequence current (ZPS)

$I_1$  = Positive phase sequence current (PPS)

$I_2$  = Negative phase sequence current (NPS)

$\text{Neg}_k$  = is weighting factor of NPS (constant value)

Presentation of the Trip with variable initial load factor:

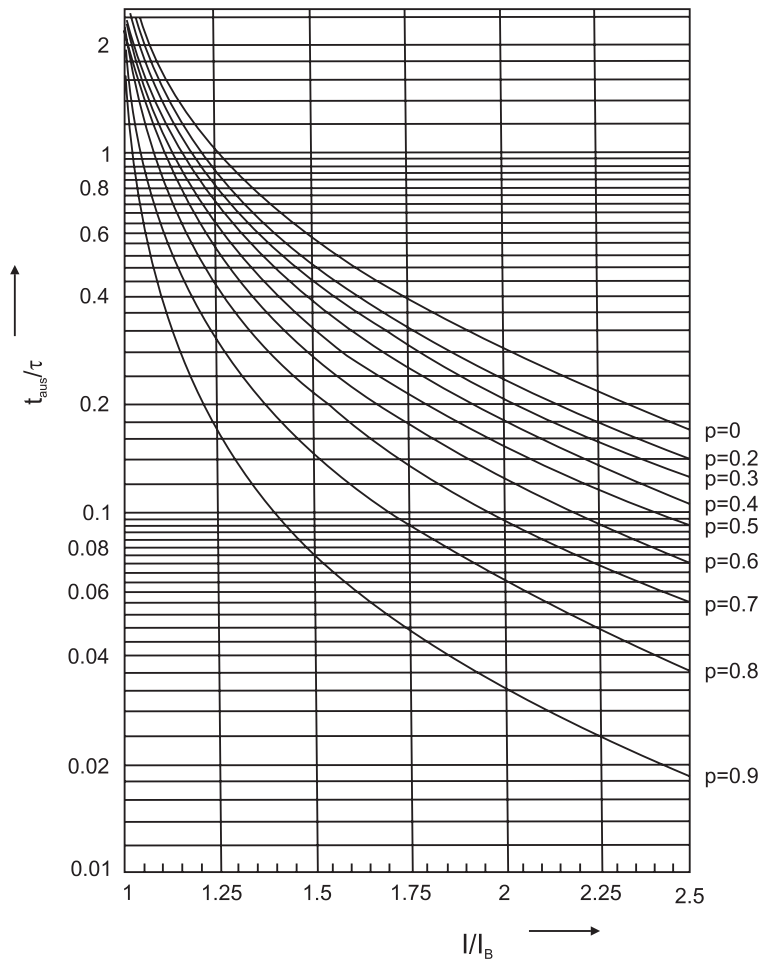

(Figure-4)

### Jam / Stall (50S)

Mechanical equipment such as pumps or fans can be quickly damaged if it jams, resulting in a locked rotor stall. Protect the motor. Load jam protection is available only when the CSENEX-M relay detects the motor in RUNNING state. During the load- jam condition the motor stalls and the phase current rises near to the locked rotor value .when the load jam tripping is enabled and the phase current exceeds the jam trip level setting for longer than the delay set time, the relay trips. Set the Jam trip level greater than the expected normal load current but less than the rated locked rotor current.

## 7.0 Monitoring Functions

### Trip Circuit Supervision (74TC)

This feature detects any anomalies in the circuit with the switch open or close. It detects trip circuit supply failure of circuit breaker, tripping mechanism failure like circuit breaker contact degeneration in wires, contacts and coils. Refer Table-8 for these protection settings.

**Note:** Trip counter is incremented on the basis of getting trip command from relay and not on the basis of external mechanism i.e. circuit breaker operation.

### Anti backspin Protection (With the name Start interval)

For certain applications, such as pumping a fluid up a pipe, the motor may be driven backward for a period of time after it stops. The CSENEX-M provides an start interval timer (minimum time between stop and restart) to prevent starting the motor while it is spinning in the reverse direction. The relay starts the timer countdown form the moment a stop is declared by the relay except in blocking state.

### Circuit Breaker Failure Protection (50BF)

The CB Failure Protection is based on supervision of current after fault tripping events. The test criterion is whether all phase/earth currents have dropped to less than 5% of  $I_n$  within the set time ( $t_{CBFP}$ ). If one or more of the phase currents have not dropped to specified current within this time, CB failure is detected and the assigned output relay is activated. Refer Table-10 for this protection setting.

### START WORKING PRINCIPLE

#### START RECOGNITATION:

CSENEX-M monitors the flow of current from which the following operational conditions of the motor are gathered

- 1) STOP
- 2) START (Resistance Start, Direct Start, Star Delta switch-over, Start-up via inverter control)
- 3) RUNNING

#### STOP- CONDITION:

If no current is measured ( $I < 5\%$  of  $I_n$ ) STOP conditions are recognized after expiry of the stop time. The stop time is adjustable in order to tolerate a brief – off time of the current flow.

#### START CONDITION:

Start is only recognized if the previous condition was STOP and the motor current has exceeded 5% of  $I_n$ . if the STOP or RUNNING conditions are recognized, the start condition is terminated.

#### RUNNING -CONDITION: RUNNING can be recognized in different ways:

1. If the start has been successfully completed. This is the case when motor current has dropped below  $KxI_b$  setting (Full load current) & the start time has elapsed (direct start).
2. If the motor is connected across several resistance steps, it is possible that  $KxI_b$  setting is crossed repeatedly. Running conditions are recognized when the start time has run out after the last step & current has settled between  $KxI_b$  and 5% of  $I_n$ . (Resistance start).
3. If after STOP a motor current has settled between 5% of  $I_n$  and  $KxI_b$  and the start reorganization time has elapsed. (Soft start)
4. If Motor Running Identification input was activated and current is 5% of  $I_n$ , then start time is bypassed, it will go in run state.

### START-STOP PARAMETERS

1. Start Time
2. Start Intervals
3. Stop Time

- 1) **Start Time:** This adjustable time has only to be extended for special start procedures in order to prevent that the running conditions are indicated too early in advance. The time is running from the instance the current flow exceeded 5% of In. Running is only accepted by the supervision after the time has elapsed.

**Case-1:** If once motor starts & I falls below 5% of In for the time less than stop time and again exceeds 5% of In then the motor comes to run state not after the set start time but after the time which was left in preceding case.

**Case-2:** If I falls below 5% of In before the expiry of start time (i.e. before run state) and remains in the state then the start timer expires after the motor get stopped (i.e. after the expires of stop timer).

- 2) **Start Interval:** This is the time allowed between two consecutive starts.
- 3) **Stop Time:** If current goes below 5% of In, then motor stops after set stop time.

## 8.0 Event Record

The unit stores in non volatile memory the last 50 events. When the available memory space is exhausted, the new event automatically overwrites the oldest event. Which can be retrieved from a PC, with the following data:

- ❖ Date and time of the event
- ❖ Descriptive text of the event

The user can view event records via the front USB interface software

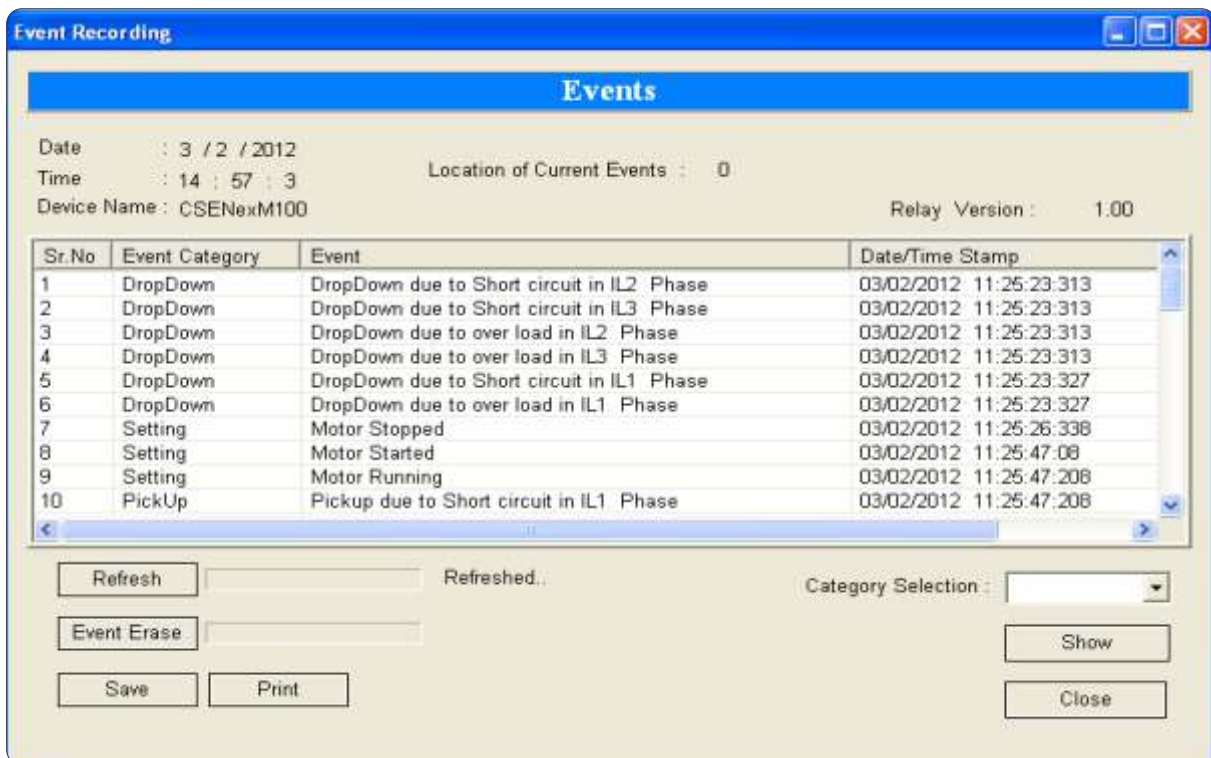

(Figure-5) Event Data recording on PC Software

### Output Contacts

- No. of digital outputs : 4 (DO1, DO2, DO3, DO4)
- Type of outputs : Relay
- Programmable (DO Assignment) : Yes
- Relay reset type inputs : Programmable (Auto/Manual)

### Input Contacts

- No of digital inputs : 4 (DI1, DI2, DI3, DI4)
- Type of inputs : AC/DC Voltage
- Programmable (DI Assignment) : Yes



## 9.0 Fault Record

The data recorded during the fault sequence is called Fault Record. CSENEX-M records last 25 faults in its non volatile memory with time stamp. Each record has following information :

- ❖ Phase & Earth fault currents
- ❖ Date and time of fault
- ❖ Origin of fault (over current, thermal .... etc.)

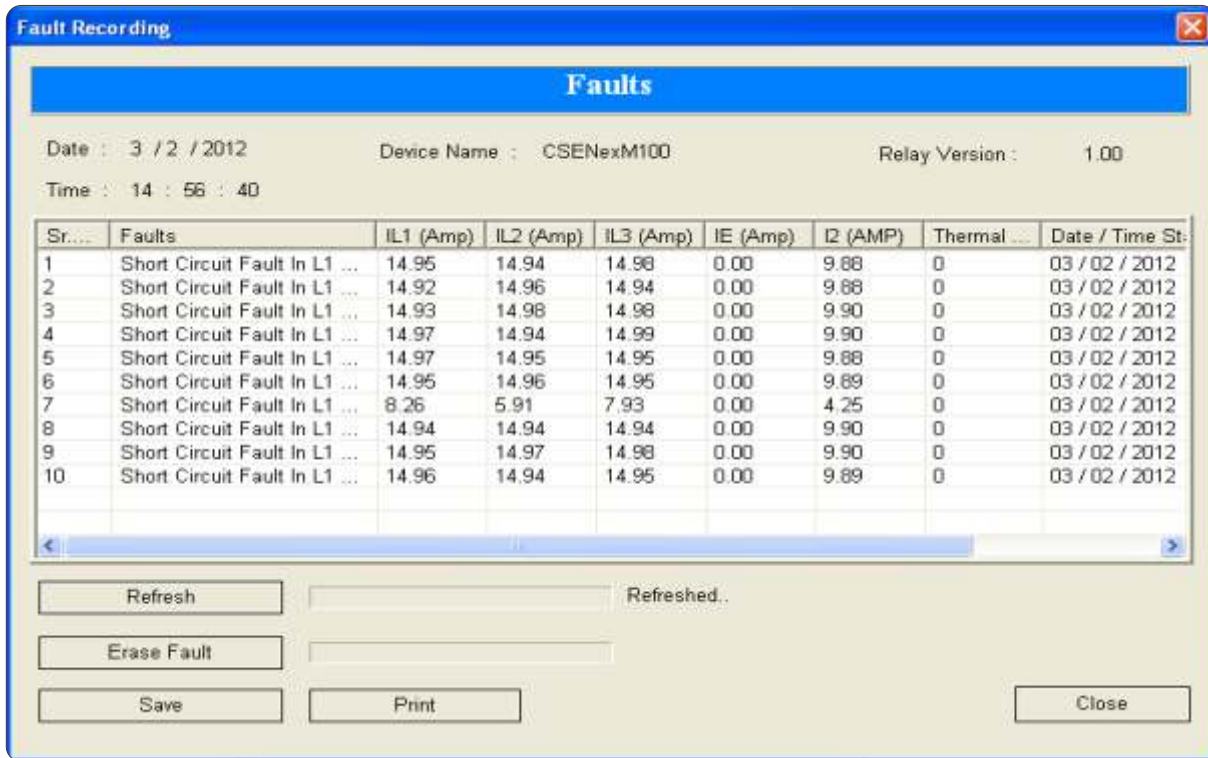

Sr...	Faults	IL1 (Amp)	IL2 (Amp)	IL3 (Amp)	IE (Amp)	IZ (AMP)	Thermal	Date / Time St:
1	Short Circuit Fault In L1 ...	14.95	14.94	14.98	0.00	9.88	0	03 / 02 / 2012
2	Short Circuit Fault In L1 ...	14.92	14.96	14.94	0.00	9.88	0	03 / 02 / 2012
3	Short Circuit Fault In L1 ...	14.93	14.98	14.98	0.00	9.90	0	03 / 02 / 2012
4	Short Circuit Fault In L1 ...	14.97	14.94	14.99	0.00	9.90	0	03 / 02 / 2012
5	Short Circuit Fault In L1 ...	14.97	14.95	14.95	0.00	9.88	0	03 / 02 / 2012
6	Short Circuit Fault In L1 ...	14.95	14.96	14.95	0.00	9.89	0	03 / 02 / 2012
7	Short Circuit Fault In L1 ...	8.26	5.91	7.93	0.00	4.25	0	03 / 02 / 2012
8	Short Circuit Fault In L1 ...	14.94	14.94	14.94	0.00	9.90	0	03 / 02 / 2012
9	Short Circuit Fault In L1 ...	14.95	14.97	14.98	0.00	9.90	0	03 / 02 / 2012
10	Short Circuit Fault In L1 ...	14.96	14.94	14.95	0.00	9.89	0	03 / 02 / 2012

(Figure-6) Fault Data recording on PC Software

Fault indicator helps the user to identify clearly the fault and to monitor relay setting and operation. When the available memory space is exhausted, the new fault automatically overwrites the oldest Fault. The user can view fault records either from the front panel or remotely via the RS-485 communication.

### Motor Start-up Record

The CSENEX-M stores the last 10 start-stop time records in non-volatile memory. when one available memory space is exhausted, the new record automatically overwrites the oldest record.

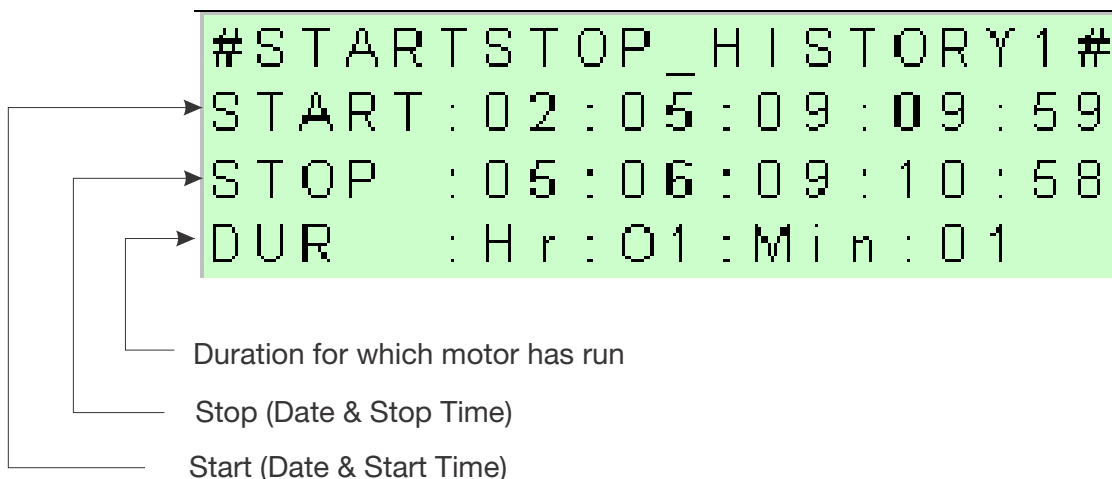

(Figure-7)

### Maxi-meter

The unit stores the maximum current value, plus the time tag for the moment when it occurs.







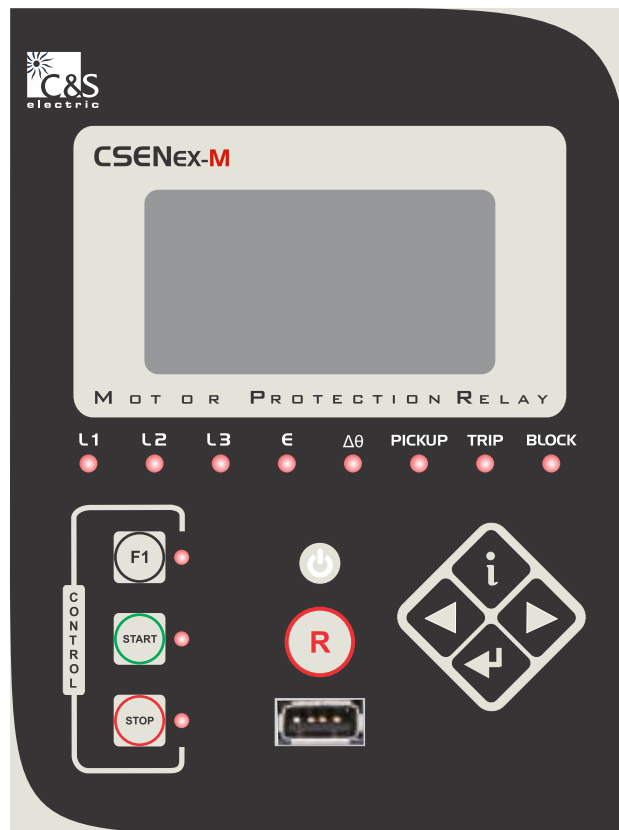

## 10.0 Human Machine Interface

It comprises bright Alpha-numeric display with 5 push buttons for setting and other operations for local access:

- ❖ Four push switches for set values of normal tripping characteristics.
- ❖ One 'RESET' push switch.
- ❖ One push switch for the function assigned in the 'HMI' to 'F1' Key, 2 push switches for the starting and stopping of motor.
- ❖ Eight LEDs for pickup or tripping on faults & events in any phase.



(Figure-8) HMI

Keys	Manual Key
	is used as intelligent key to see the details of the last fault, fault pickup status, digital input & output status.
	is used as a "ENTER" key.
	is used to manual reset (after pressing for 2 sec)
	is used to scroll in upward direction and for decrement of parameters.
	is used to scroll in downward direction and for increment of parameters.
	To perform the assigned task either DO Trip, DO Reset or thermal reset.
	To start the motor (via assignable DO).
	To stop the motor (via assignable DO).

## 11.0 Communication (Local & Remote)

The unit has:

- ❖ 1 Front USB port for direct connection to a PC.
- ❖ 1 Rear RS-485 communication port.

### Rear Communication (RS-485/RJ-45)

The protocol for the rear port is MODBUS.

### Front Communication (USB)

The entire setting including protection parameter setting, Fault & Event records are available on 'A' type USB (female) interface with saving & printing option (See Figure-9). This unit also has Front-end Live Link simulation support for testing of relay even without any three phase injection source.

### PC interface

All the group's setting, Fault and Event are available on USB interface with saving & printing option. This unit also has Front-end Live Link simulation support for testing of relay even without any three phase injection source.

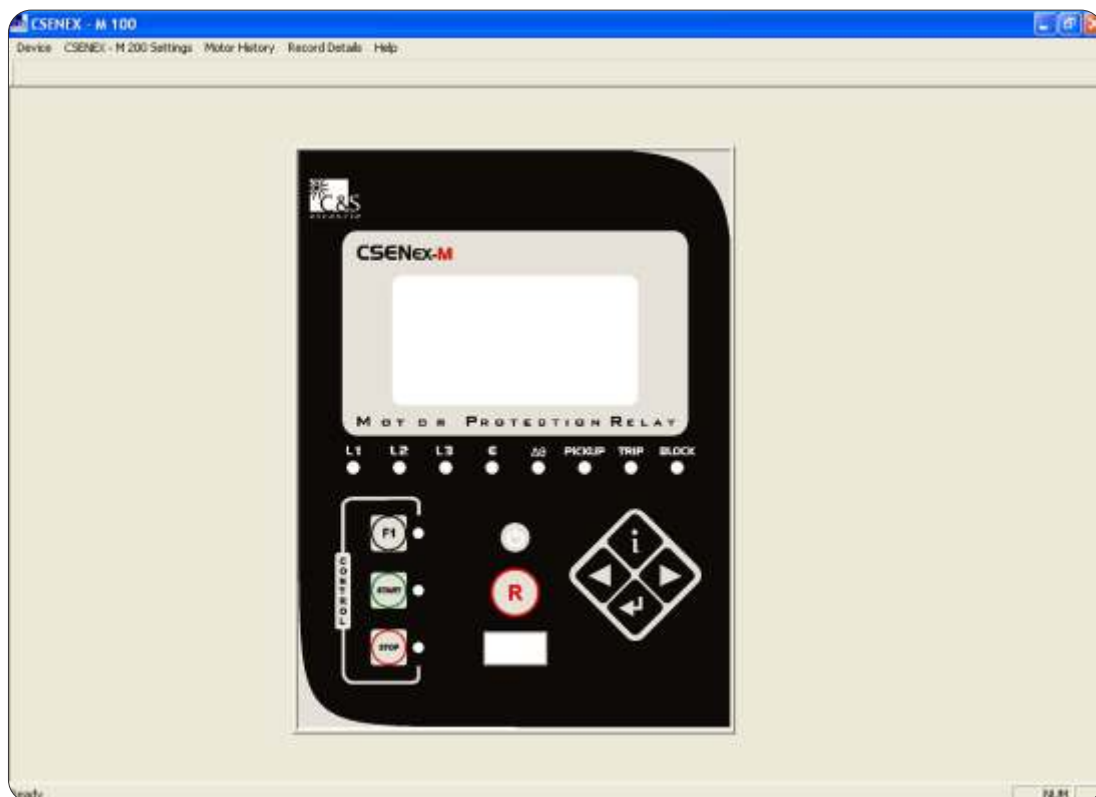

(Figure-9)

## 12.0 Setting Ranges

### Current Protection

Parameters	Display	Setting Ranges		Step Size	Default Setting
		Min	Max		
Phase trip characteristics	CURVE	DEFT	EINV, VINV, LINV NINV1.3, NINV3.0	-	DEFT
Phase over-current Low set pickup setting	l>	0.20xlp	4.00xlp	0.05	Exit
Phase over-current Low set inverse timing	ti>	0.04	260.00	0.01	000.10
Phase over-current Low set definite timing	t>	0.05s	260s	0.01s	000.10s
Under-current pickup setting	l<	0.20xlp	1.00xlp	0.01xlp	Exit
Under-current timing	t<	0.05s	260.00s	0.01s	001.00s
Phase over-current Hi-set pickup setting	l>>	0.20xlp	30.00xlp	0.02	Exit
Phase over-current Hi-set definite timing	t>>	0.04s	20.00s	0.02s	00.04s

(Table-1)

### Thermal Over-load

Parameters	Display	Setting Ranges		Step Size	Default Setting
		Min	Max		
Thermal memory mode	ThMemMod	M1	M2, M3	-	M1
Permissible basic current	lb	0.20xlp	4.00xlp	0.02xlp	Exit
Constant	k	0.50	2.00	0.01	1.00
Heating time constant	Th	0.5mn	180.0mn	0.1mn	000.5mn
Cooling constant	Tc	1.00xTh	8.00xTh	0.01xTh	1.00xTh
Thermal alarm	Th_Alrm	20%	99%	1%	20%
NPS weighting factor	l2_Wgt	0.05	2.50	0.05	2.50
Thermal reset	Thrm_Rst	0%	99%		70%
Thermal trip characteristic	ThrmChar	th1	th2		th1

(Table-2)

### Earth Protection

Parameters	Display	Setting Ranges		Step Size	Default Setting
		Min	Max		
Earth trip characteristics	CURVE	DEFT	EINV, VINV, LINV NINV1.3, NINV3.0	-	DEFT
Earth over-current Low-set pickup setting	le>	0.05xln	2.50xln	0.05xln	Exit
Earth over-current Low set inverse timing	tie>	0.05	20.00	0.05	00.10
Earth over-current Low set definite timing	te>	0.03s	260.00s	0.01s	000.03s
Earth over-current Hi-set pickup setting	le>>	0.50xln	8.00xln	0.05xln	Exit
Earth over-current Hi-set definite timing	te>>	0.02s	20.00s	0.01s	00.03s

(Table-3)

(1) Refer following formula for EINV, VINV, LINV, NINV1.3, NINV3.0 characteristics:

$$\text{Very Inverse} \quad t = \frac{13.5}{(I / I_s) - 1} \quad t_i \text{ [s]}$$

$$\text{Extremely Inverse} \quad t = \frac{80}{(I / I_s)^2 - 1} \quad t_i \text{ [s]}$$

$$\text{Long time Inverse} \quad t = \frac{120}{(I / I_s) - 1} \quad t_i \text{ [s]}$$

$$\text{Normal Inverse 3.0/1.3} \quad t = \frac{0.14/0.061}{(I / I_s)^{0.02} - 1} \quad t_i \text{ [s]}$$

Where  $t$  = Tripping time     $t_i$  = Time multiplier  
 $I$  = Fault current     $I_s$  = Setting value of current

Trip Time Accuracy : DEFT/VINV/NINV3.0/1.3 :  $\pm 5\%$  or  $\pm 30\text{mSec}$  (whichever is higher)  
 EINV/LINV :  $\pm 7.5\%$  or  $\pm 40\text{mSec}$  (whichever is higher)

### Motor Control Setting

Parameters	Display	Setting Ranges		Step Size	Default Setting
		Min	Max		
Starting time	StrtTime	0.20s	500s	0.01s	3.00s
Start interval time	StrtIntrvl	1mn	240mn	1mn	Exit
Stop time (stop recognition delay)	StopTime	0.20s	10.00s	0.01s	3.00s
Phase loss trip time	TPhIs	0.10s	10.00s	0.01s	Exit
Lock rotor pickup setting	LckRtr_I	2xlp	30xlp	2xlp	Exit
Lock rotor trip time	LckRtr_t	0.04s	20.00s	0.01s	0.10s
Stall / Jam pickup setting	Stall_I	0.5xlp	30xlp	0.1xlp	Exit
Stall trip time	Stall_t	1s	60s	1s	05s

(Table-4)

### DO Assignment

Parameters	Display
Over-current protection	I>
Short circuit protection	I>>
Under-current	I<
Earth timed protection	Ie>
Earth instant protection	Ie>>
Negative phase sequence protection	I2>
Circuit breaker failure protection	CBFP
Start block	StrtBlck
Common fault	CommonFlt
Start relay	StartRly
Stop relay	StopRly
Thermal relay	ThrmIRly
Thermal alarm	ThrmIAlrm
Phase loss	PhLoss
Stall	Stall
Lock rotor	LockRotr
Trip circuit supervision	TCS
Motor running	MotorRun
Self supervision	SlfSpvsn

(Table-5)

### DI Assignment

Parameters	Display
Circuit breaker open	CB_open
Circuit breaker close	CB_close
Remote start	Rmtstart
Remote stop	Rmtstop
Remote reset	RmtRSET
Over-current blocking	OC_BLK
Short circuit blocking	SC_BLK
Earth timed blocking	EL_BLK
Earth instant blocking	EH_BLK
Lock rotor blocking	LkRtrBLK
Stall blocking	StallBLK
Phase loss blocking	PhLosBLK
Thermal blocking	ThrmBLK
NPS blocking	NPS_BLK
Under-current blocking	UC_BLK
Motor running identification	MtrRunng
Emergency start	EmrgStrt

(Table-6)

### Function Reset

Parameters	Display	Setting Ranges	
		Min.	Max.
Over-current protection	I>	Auto	Manual
Short circuit protection	I>>	Auto	Manual
Under-current	I<	Auto	Manual
Earth timed protection	Ie>	Auto	Manual
Earth instant protection	Ie>>	Auto	Manual
Negative phase sequence protection	I2>	Auto	Manual
Start block	StrtBlck	Auto	Manual
Common fault	CommonFit	Auto	Manual
Thermal relay	ThrmIRly	Auto	Manual
Thermal hooter	ThrmIArm	Auto	Manual
Phase loss	Ph Loss	Auto	Manual
Stall	Stall	Auto	Manual
Lock rotor	LockRotr	Auto	Manual
Trip circuit supervision	TCS	Auto	Manual
Motor running	MotorRun	Auto	Manual

(Table-7)

### Key Assignment

Relay is having one function key (F1). It can be assign to trip any of 6 DO or to Relay reset, Thermal reset of the relay.

Parameters	Display	Setting
Function key	F1	DO1/DO2/DO3/DO4 Relay Reset, Thermal Reset

(Table-8)

### Trip Circuit Supervision Protection (74TC)

Parameters	Display	Setting Ranges		Step Size	Default Setting
		Min	Max		
Trip circuit supervision time delay	td	0.03s	2.00s	0.01s	Exit

(Table-9)

### Circuit Breaker Failure Protection (50BF)

Parameters	Display	Setting Ranges		Step Size	Default Setting
		Min	Max		
Circuit breaker failure protection time delay	td	0.03s	2.00s	0.01s	Exit

(Table-10)

### Negative Phase Sequence Setting (46)

Parameters	Display	Setting Ranges		Step Size	Default Setting
		Min	Max		
NPS trip characteristic	CHAR	DEFT	NEG_INV	-	DEFT
NPS pickup setting	I2s	0.10xlp	1.00xlp	0.01xlp	Exit
Time multiple	K1	5s	600s	1s	005s
Definite time delay	td	0.1s	600s	0.1s	0.5s

(Table-11)

### Common Setting

These are the setting's common for all the protections:

Parameters	Display	Setting Ranges		Step Size	Default Setting
		Min	Max		
Phase CT ratio	PhsCTRatio	1	9999	1	1
Earth CT ratio	ErthCTRtio	1	9999	1	1
Rated phase current	lp	1.00A	5.00A	-	1.00A
Rated earth current	ln	1.00A	5.00A	-	1.00A
Nominal frequency	NominalFrq	50 Hz	60 Hz	-	50Hz
Fault Pop Up	Faultpop up	ENBL	DISB	-	ENBL

(Table-12)

### Rear Port Communication Setting

RS-485 Communication	
Protocol	MODBUS RTU
Baud rate selection (Programmable)	4800/ 9600 / 19200 / 38400 / 57600 bps
Parity selection (Programmable)	Even / Odd / None
Stop bit	1 Bit
Data bit	8 Bit
Remote Address (Programmable)	247
Cable required for interface	Two wire twisted shielded cable

(Table-13)

USB Communication	
Protocol	CSE Proprietary Protocol available with front software
Baud rate	19200 bps
Cable required for Interface	USB cable type (A to A)

(Table-14)

## 13.0 Technical Data

### Measuring Input

Rated Data	Rated Current $I_p$ : 1A & 5A
	Rated Frequency $F_n$ : 50Hz / 60Hz
Thermal withstand capability in current circuit	At $I_p$ : 1A
	Continuous = 5 x $I_p$
	for 10 Sec = 30 x $I_p$
	for 1Sec = 100 x $I_p$
	At $I_p$ : 5A
	Continuous = 3 x $I_p$
for 10 Sec = 10 x $I_p$	
for 1Sec = 20 x $I_p$	
Nominal Burden	For phase = < 0.2VA
	For earth = < 0.2VA

(Table-15)

### Measurement Accuracy

Parameters	Range	Frequency Range	Accuracy
Current in Ampere	1.0-30.0x $I_p$	50-60Hz	$\pm 2\%$

(Table-16)



### Auxiliary Supply

Auxiliary Voltage Range	For 'L' Model	18V-60V DC
	For 'H' Model	85V-280V AC / 110V-300V DC
Supply Range for Digital Input	For 'L & H' Model	Above 24V AC/DC
Power Consumption	Quiescent approx. 3W	Operating approx. <7W

(Table-17)

### Common Data

Dropout ratio	> 96%
Relay Reset time	30 ms
Minimum operating time	30 ms
Transient overreach at instantaneous operation	≤5%

(Table-18)

### Trip Contact Rating

<b>Contact Rating</b>	
Contact relay	Dry contact Ag Ni
Make current	Max. 30A & carry for 3S
Carry capacity	8A continuous
Rated voltage	250V AC/ 30V DC
<b>Breaking Characteristics</b>	
Breaking capacity AC	1500VA resistive 1500VA inductive (PF=0.5)
Breaking capacity DC	220V AC, 5A (cosØ ≤0.6)
	135V DC, 0.3A (L/R=30ms) 250V DC, 50W resistive or 25W inductive (L/R=40ms)
Operation time	<10ms
<b>Durability</b>	
Loaded contact	10000 operation minimum
Unloaded contact	30000 operation minimum

Over-voltage category : II  
 Insulation voltage : 300V  
 Pollution Degree : 2  
 IP 54 from Front

(Table-19)

## 14) Standards

Type Test			
F1	Functional Tests	Internal Design	Performance in line with Specification & Standards
		Specifications & IEC60255-6 IEC60255-3	Pickup/Drop down/Power consumption in Current/Voltage/Aux Supply/Trip timing accuracy: OC/ Directional/NPS/Thermal/OV/Zero Seq/Over Power/ freq/Rate of change of Freq

Climatic Test			
C1	Temperature Dry Cold (Relay operational)	IEC 60068-2-1	-20 deg C, 96 hours
C2	Temperature Dry Cold Transportation & Storage	IEC 60068-2-1	-25 deg C, 96 hours
C3	Temperature Dry Heat (Relay operational)	IEC 60068-2-2	55 deg C, 96 hours
C4	Temperature Dry Heat Transportation & Storage	IEC 60068-2-2	70 deg C, 96 hours
C5	Damp Heat Test (Relay operational)	IEC 60068-2-3	95% @ +55 / +25 deg C, 6 cycle (12hr + 12hr each)

Enclosure			
C6	Enclosure	IEC 529	Front IP54 (Dust 5x + Water x4)

### Mechanical Test

Relay Operational			
M1	Vibration response / Endurance test	IEC 60255-21-1	Class I Vibration response (Relay operational) 10Hz~150 Hz - peak displacement 0.035 mm below 58/60 Hz, 0.5 g above, 1 sweep cycle in each axis Vibration endurance (Relay de-energised) 10 Hz~150 Hz 1g, 20 sweep cycles in each axis
M2	Shock Response / Withstand Test	IEC 60255-21-1	Class I Shock response (Relay operational) 5g 11mS 3 pulse in each axis Shock withstand (Relay de-energised) 15g 11mS 3 pulses in each axis
M3	Bump	IEC 60255-21-1	Bump (Relay de-energised) 10g 16mS 1000 pulses in each axis
M4	Seismic	IEC 60255-21-3	Class I Method A single axis sine sweep 1 Hz~35 Hz~below 8/9 Hz 3.5 mm peak displacement horizontal axis, 1.5 mm vertical axis above 8/9 Hz 1g horizontal, 0.5 g vertical 1 sweep cycle in each axis

Electrical Test			
E1	Insulation Resistance >100MΩ	IEC 60255-5	500V DC, 5 sec between all terminals & case earth, between terminals of independent circuits including contact circuits and across open contacts
E2	DC & AC Supply Voltage (Relay operational)		IEC 60255-6 Voltage range, upper & lower limit continuous withstand, ramp up & down over 1 minute
E3	Voltage Dips, Short Interruptions & Voltage variations immunity (Relay operational)	IEC 1000-4-11	IEC 60255-113 Dips & 3 Interruptions at 10 sec intervals of duration between 10mS and 500mS at zero crossings & at other points on wave Variation: 100% to 40% over 2s, hold for 1s, return to 100% over 2s
E4	Ripple in DC supply (Relay operational)	IEC 60255-11	12% AC ripple
E5	Dielectric Test (Relay de-energised) No breakdown or flash over Test voltage 45-65 Hz sinusoidal or with DC voltage at 1.4x the stated AC values	IEC 60255-5	2.0 KV @ 1min All circuit to Earth / Between IP & OP
E6	High Voltage Impulse (Relay de-energised)	IEC 60255-5	5 kV peak 1.2/50uS, 0.5 J-3 positive, 3 negative between all terminals to case earth between independent circuits
E7	VT Input Thermal Withstand		1.5xVn, continuous
E8	CT Input Thermal Withstand		250xIn half wave 100xIn for 1 second 30xIn for 10 second 4xIn continuously
E9	Contact performance & endurance tests	IEC 60255-14,15 IEC 60255-23	

Electro-magnetic Compatibility			
R1	Electrical fast Transient/Burst (Relay operational)	IEC 60255-22-4  IEC 60100-4-4	Class IV- $\pm 4.0$ kV All Circuits. Pulse 5/50nsec/Duration 15msec/ Period: 300msec/Pulse Freq: 5KHz / 2KV at I/O
R2	HF Disturbance Test (Oscillatory Waves) 1 MHz Burst (Relay operational)	IEC 60255-22-1	Class III Longitudinal 2.5 kV peak, 2sec between independent circuits & case earth
R3	Electrostatic Discharge (Relay operational )	IEC 60255-22-2 IEC 61000-4-2	Class III 8kV air discharge, 6KV contact No of Discharge : 10 both polarities at 1 sec intervals
R4	Conducted Disturbance RF fields (Relay operational)	IEC 61000-4-6 IEC 60255-22-6	0.15 to 80 MHz (Level-3) Severity Level 10V RMS + sweeps 0.05-0.15 MHz & 80-100 MHz
R5	Radiated RF E-M field immunity test (Relay operational)	IEC 60255-22-3 IEC 61000-4-3	Class III Test method A + sweep 80-1000 MHZ or IEC 1000-4-3 80-1000 MHZ severity 10 V/m 80% modulated 1 kHz
R6	Surge Immunity capacitively coupled (Relay operational)	IEC 61000-4-5 Class 5 Test level 4 IEC 60255-22-5: 2008 Latest: IEC 60255-26:2013	Short circuit combination wave generator 1.2 uS/50 uS open circuit repetition rate 1 per minute Power supply, CT & VT circuits – 4kV common mode 2 Ohm source 2kV differential mode 12 Ohm source
R7	Power Frequency Magnetic Field (Relay operational)	IEC 61000-4-8	100 A/m for 1 minute in each of 3 axes
R8	Conducted & Radiated RF Interference Emission (Relay operational)	EN55011 IEC 60255-25	CISPR11/ Class A
R9	Power Frequency, conducted common mode	IEC 1000-4-16 IEC 60255-22-7	D.C. to 150 kHz Test Level 4 300V at 16 2/3 Hz and 50 Hz

## 15.0 Trip Circuit Supervision Diagram

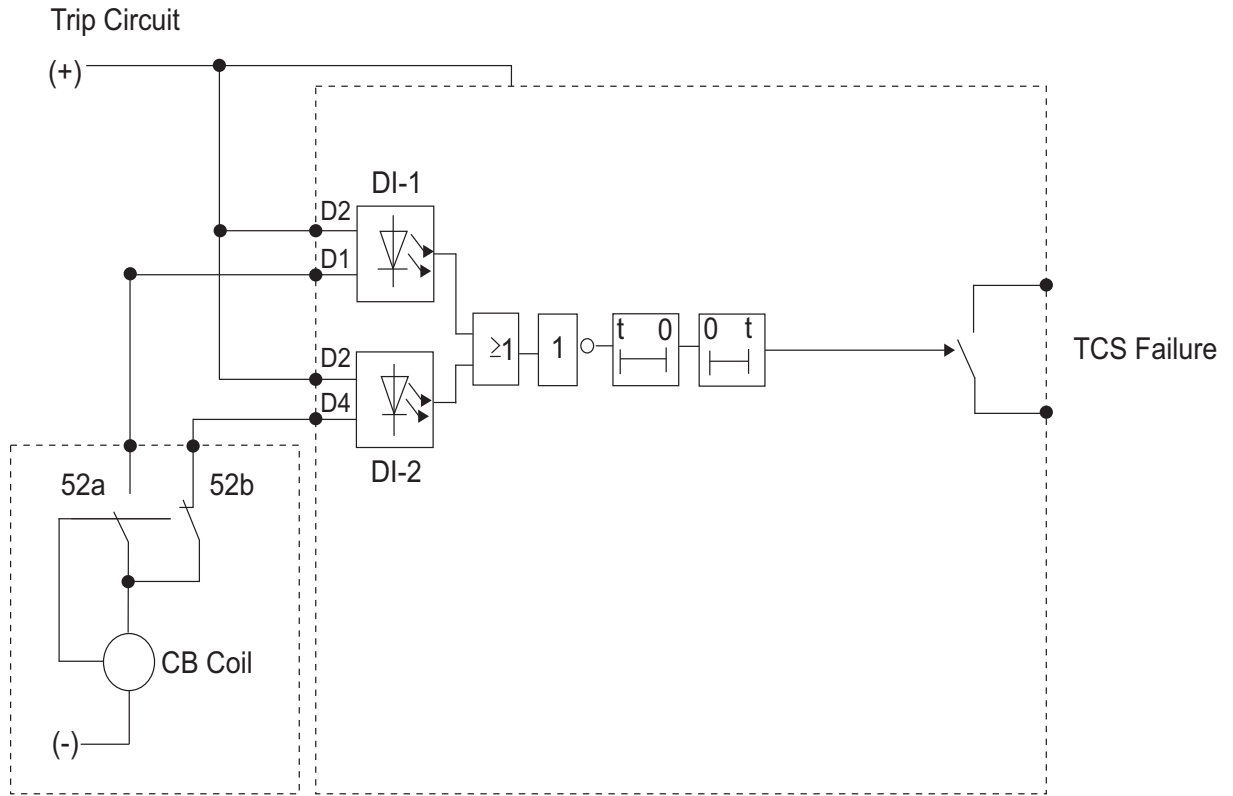

(Note: CB coil resistance should be such that at least 4mA current must flow in each Digital Input)

## 16.0 Connection Diagram

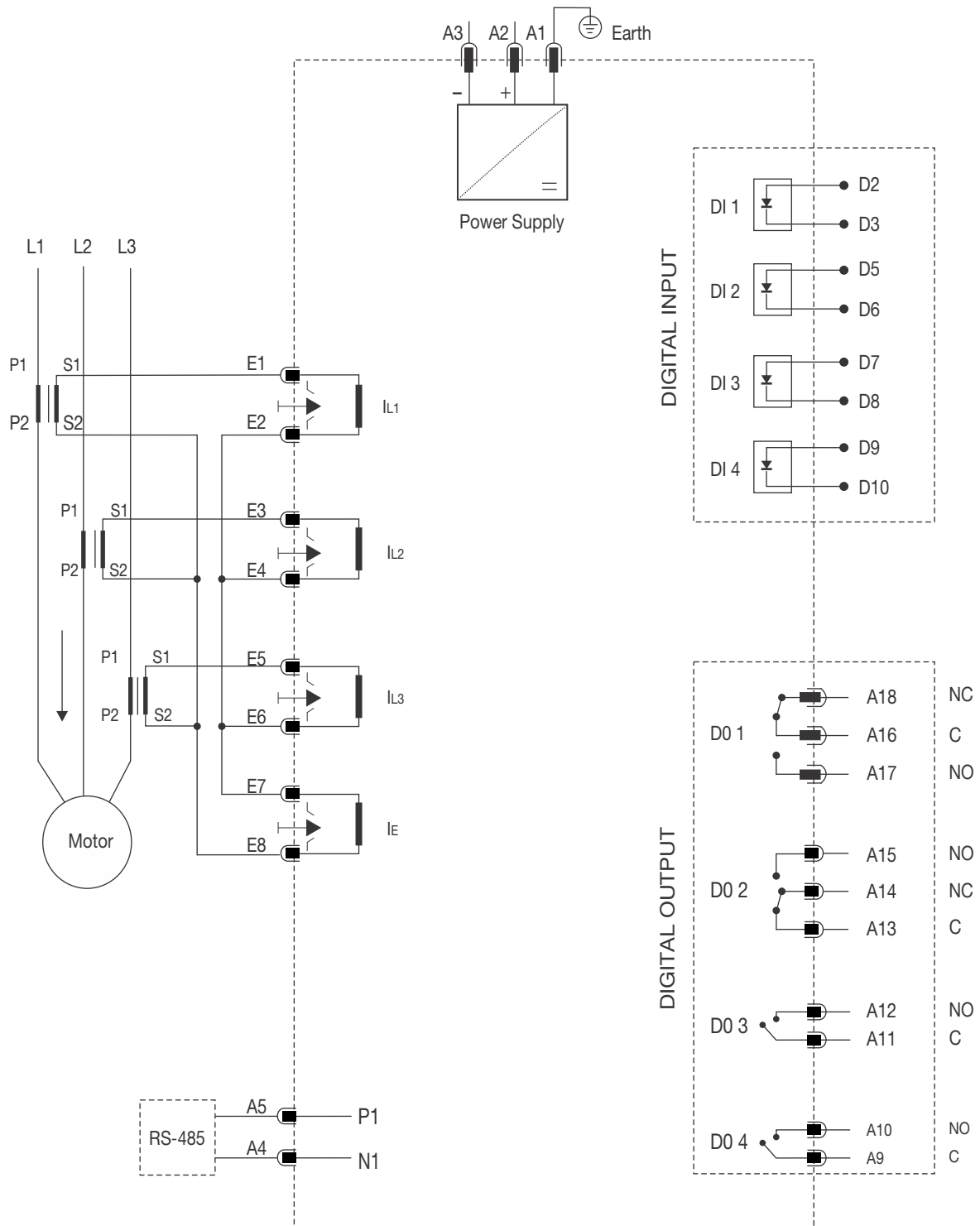

(Figure-11)

## 17.0 Dimensional Details

(All the dim. are in mm, Gen. Tol.:  $\pm 1.0\text{mm}$ )

### Front View

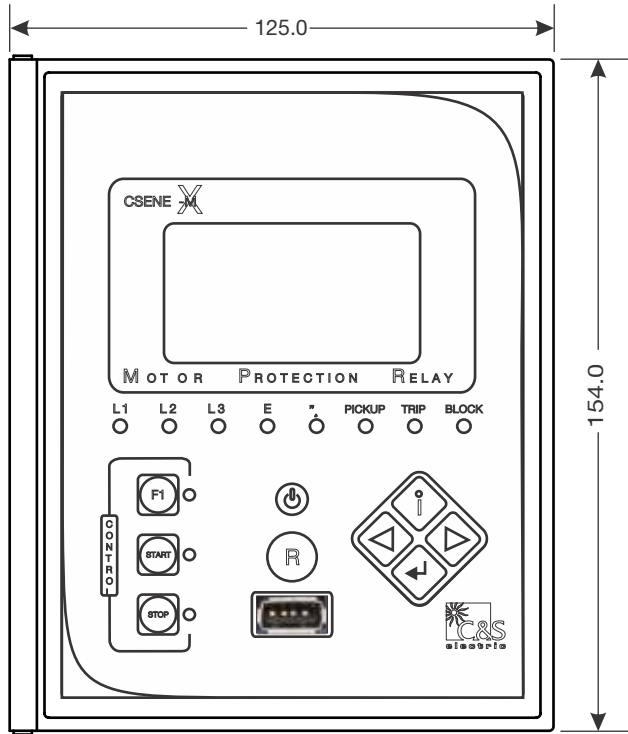

(Figure-12)

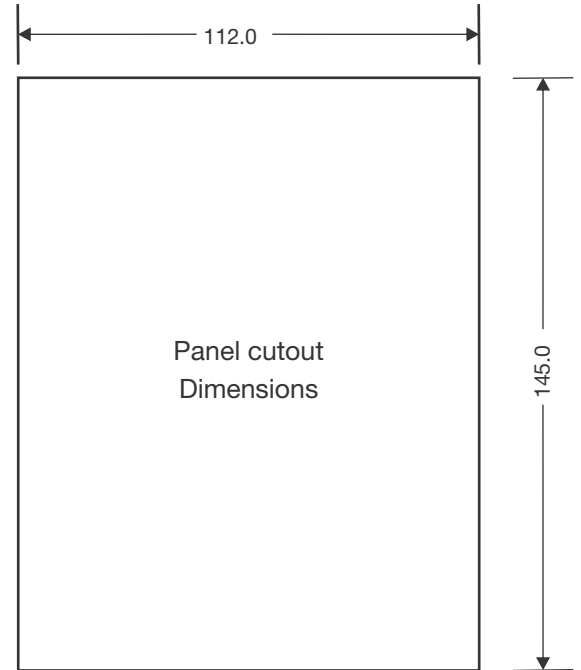

(Figure-13)

### Side View

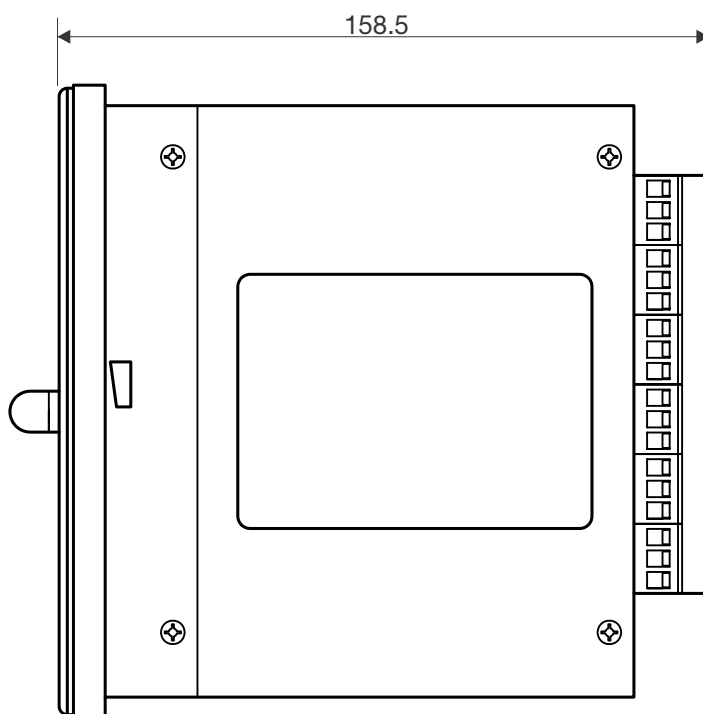

(Figure-14)

## 18.0 Ordering Information

