

We touch your **electricity** everyday!

## CSENEX-I 203

Intelligent Measuring and Protection Device

CSENEX  
Series



Catalogue

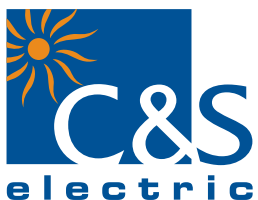

Protection & Measurement Devices

# INDEX

S.No.	Description
1.	Introduction
2.	Features
3.	Application
4.	Hardware
5.	Protection Features
6.	Functional Diagram
7.	Fault Recording
8.	Event Recording
9.	Human Machine Interface
10.	Communication
	10.1 Rear Communication
	10.2 Front Communication
11.	Setting Ranges
12.	Technical Data
13.	Type Test
14.	Technical Test
15.	Model Description Table
16.	Connection Diagram
17.	Back Terminal Diagram
18.	Dimensional Details
19.	Ordering Information



## 1) Introduction

CSENX Series offers a compact Multi-functional Over-current protection solution for Feeder, Generator, Motor & Transformer segment.

CSENX-I Family of protective relays are numeric relays that provides multi protection and monitoring with reliable and fast protection solution in a single unit.

In this family of CSENX series, the CSENX-I is an advanced feeder protection solution which has fast, sensitive and secure protection for feeder internal & external faults.

CSENX-I offers different model based features to cover the wide range of user.

## 2) Features

- ❖ 1A & 5A rated CT input (programmable).
- ❖ Three phase time over-current protection.
- ❖ Draw out with self CT shorting.
- ❖ Three phase instantaneous protection.
- ❖ Earth time over-current and earth instantaneous over current.
- ❖ Negative phase sequence.
- ❖ Protection against broken conductor.
- ❖ Circuit breaker failure detection.
- ❖ Trip circuit supervision.
- ❖ Programmable auto-reclosing by selecting number of cycles for a particular fault.
- ❖ Event recorder.
- ❖ Fault recorder.
- ❖ DI/DO programmable matrix.
- ❖ Protection blocking through DI.
- ❖ Communication (Local & Remote).

## 3) Application

The CSENX-I relays have been designed for controlling, protecting and monitoring industrial, utility distribution networks and substations. They can also be used as part of a protection scheme for feeders, transformers and generators.

## 4) Hardware

- ❖ Digital Signal Processor based numeric design.
- ❖ Measures true RMS with DFT filter .
- ❖ 4 Current analog inputs for phase & earth fault current.
- ❖ 6 Digital Inputs.
- ❖ 4 Digital Outputs.
- ❖ 12 x 2 Alpha-numeric LCD.
- ❖ RS-485 & USB communication.
- ❖ 1 A & 5A common current terminal and programmable.
- ❖ 8 LEDs for pickup and trip on fault.

## 5) Protection Features

- ❖ Three phase time over current protection (51).
- ❖ Three phase instantaneous protection (50).
- ❖ Earth time over-current (51N).
- ❖ Earth instantaneous over-current (50N).
- ❖ Current unbalance (46).
- ❖ Broken conductor (46BC).
- ❖ Residual over-voltage (neutral displacement)
- ❖ Circuit breaker failure protection (50BF)

## 6) Functional Diagram

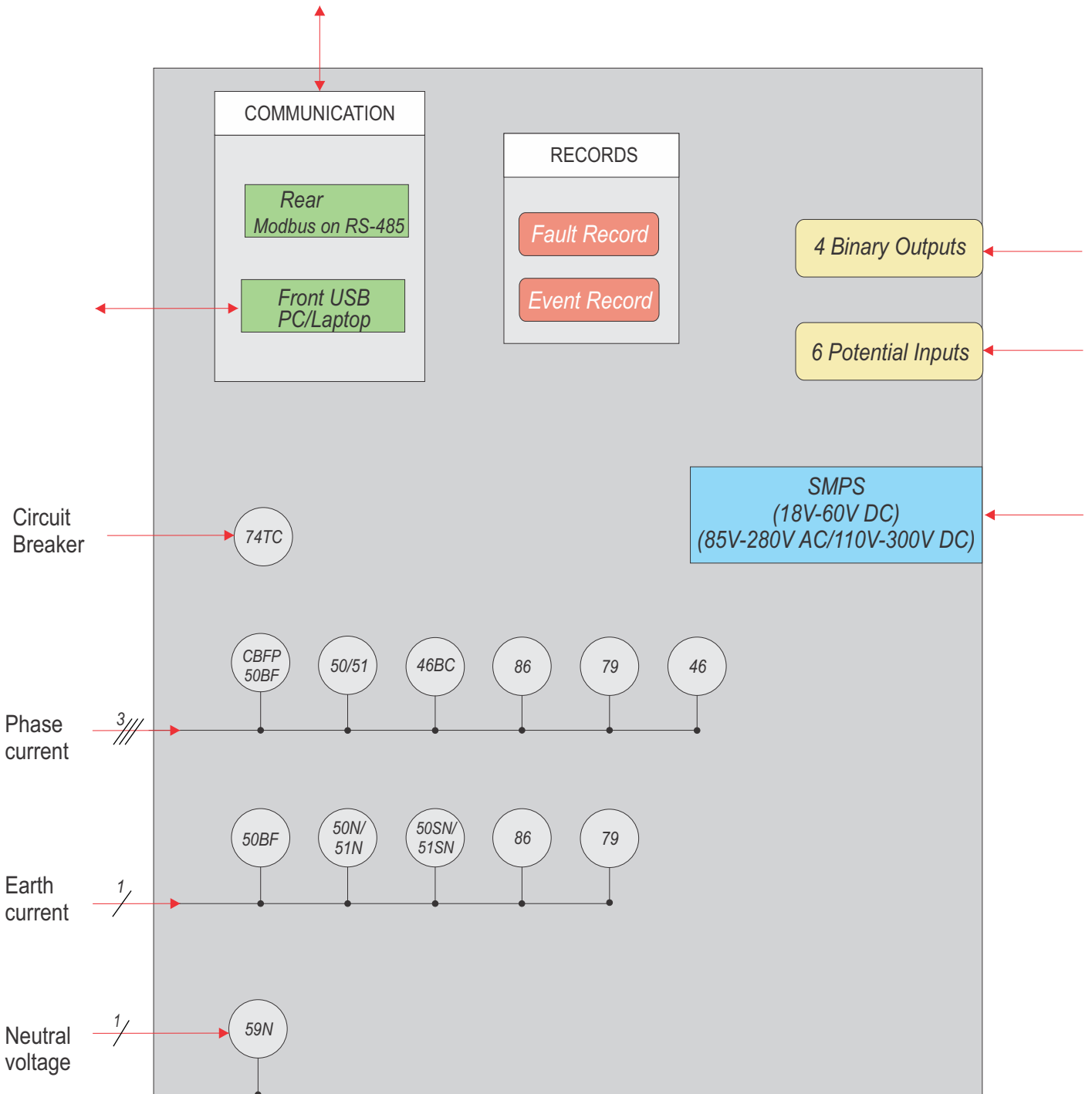

(Figure 1)

## Protection Function

### Three Phase Over-current Protection (50/51)

The independent two stages are available for phase fault protection. For I> the user may independently select definite time delay or inverse time delay with different type of curves. The second Hi-Set stage can be configured with definite time only.

### Earth Fault Protection (50N/51N)

The independent two stages are available for earth fault protection. For first stage (Ie>) the user can select definite time delay or inverse time delay with different type of curves. The second Hi-Set stage can be configured with definite time only.

If neutral displacement option is selected then earth fault pick-up is considered only when neutral voltage is above the set level.

### Broken Conductor Protection\* (46BC)

For giving this protection the ratio of -ve phase sequence current and +ve phase sequence current is measured. The delay timer starts when the ratio exceeds the set value and tripping is initiated as soon as set time is elapsed.

### Current Unbalance (46)

It contains the inverse and definite time characteristics. This protection works exactly in the same way as phase over current but I2> is combination of all three current. Its amplitude also depends on the phase angle.

$$3 |I_2| = |I_a + a^2 \cdot I_b + a \cdot I_c|$$

Where a =  $\sqrt[3]{120}$

### Relay Latching (86)

Relay can be configured to Latch /Unlatch depending on configuration.  
(Latching is possible in presence of Auxiliary supply voltage only)

### Trip Circuit Supervision (74TC)

This feature continuously supervises trip circuit of both pre closing and post closing conditions in circuit breaker. It detects tripping mechanism failure like circuit breakage contact degeneration in wires, contacts and coils.

Note: Trip counter is incremented on the basis of getting trip command from relay and not on the basis of external mechanism (circuit breaker) operation.

### Harmonic Restrain

Harmonic setting is by default 20% of injected current. Phase/Earth Harmonics can be Blocked/Unblocked & time setting can also be edited through MMI. If the Pickup current has %harmonics above 20%, the protection will be blocked for the harmonics blocking time. Tripping occurs according to the higher time setting i.e. if the harmonics time setting is greater it will trip according to the harmonics time setting otherwise according to the fault time setting.

### Circuit Breaker Failure Protection (50 BF)

The CB Failure Protection is based on supervision of phase and earth currents after tripping events. The test criterion is whether all phase currents have dropped to less than 5% of In within tCBFP. If one or more of the phase currents have not dropped to specified current within this time, CB failure is detected and the assigned output relay is activated.

### Auto Recloser Strategy (79)

As 80% of faults in overhead lines are transient, the use of the auto recloser is very advantageous. Automatic auto-recloser allows a substation to operate unattended. The number of visits on site to manually reclose a circuit breaker after a fault, can then be substantially reduced. This feature gives an important advantage for substations supervised remotely.

Typically this auto reclose (AR) sequence of Instantaneous Trip(s) and Reclose Delays (Dead times) followed by Delayed Trip(s) provide the automatic optimum method of clearing all types of faults i.e. both Transient and Permanent, as quickly as possible and helps in improving the up time of the network in service.

### DI Inputs:

AR Blocking - To block the auto recloser through remote DI  
CB Close DI - To get the circuit breaker status  
CB Ready - To get the CB ready or to give the closing command

### Configurable Outputs:

79 AR Close CB  
79 Lockout

### AR-Blocked:

Unit changes immediately to "AR-blocked" status when an external AR Blocking DI is applied or internal EXIT is chosen for AR cycle in MMI. No Auto reclosing is possible in "AR-blocked" status.

### Activating of AR:

Prior to every AR it is possible to select which kind of tripping (I> or I>>, Ie> etc.) will lead to automatic re-closing. This can be separately fixed for each protection.

**Dead time (td):** Starts with the off signal of the circuit breaker. No closing command to the circuit breaker is given till expiry of the set dead time.

User programmable dead times are available for each protection trip operation.

The dead time is initiated when the trip output contact resets, the pickup is reset and the CB is open.

The CB close output relay is energized after the dead time has elapsed if CB ready input is present.

The dead time (dead time td1, dead time td2, dead time td3, dead time td4) starts when the feedback on 'CB CLOSE DI' is not available.

**NOTE: Trip Test is available in HMI to check all LEDs and Digital Output (Relay)**

### Reclaim time (tr):

This is the time during which after switching on or after AR a subsequent re-closing is prevented.

If the number of the set shots is reached, the relay is locked for this time after the last re-closing attempt.

If CB Ready DI is not available relay will not generate closing command.

If the circuit breaker dose not trip again, the auto re-close cycle resets to original STATE-1 at the end of the reclaim time.

If the protection operates during the reclaim time of the relay:

- ❖ either advances to the next AR cycle that is expected in next auto re-close state or
- ❖ if all the programmed re-closer attempts have been accomplished, it locks out.

The reclaim time is started with the automatic closing command.

Once a CB has re-closed and remained closed for a specified time period (the reclaim time), the AR sequence is reinitialized and a successful close output issued. A single common reclaim time is used (Reclaim Timer). when an auto re-close sequence does not result in a successful re-closure the relays goes to the lock out state.

### Starting Condition for Auto Re-closer

- 1) AR should be enabled by manual setting.
- 2) AR blocked DI is not available
- 3) Respective protection AR cycle should not in exit condition.

### Lock out State

Lockout state of the breaker means no further attempts to AR in these conditions

- 1) Lockout occurs when all auto re-closure attempts are over and protection operates during the final Reclaim Time.
- 2) If CBFP failure appeared in relay (if CBFP enable).
- 3) At the end of the each reclaim timer if the CB is in the open position (Close DI is not present).
- 4) If a Close pulse of AR relay is given and the CB fails to close through close DI input or expiry of Trip Contact Sense time.
- 5) If a open pulse given to CB and CB fails to open in between Trip Contact Sense time.

In any of these cases, Manual reset will be required to reinitiate the AR.

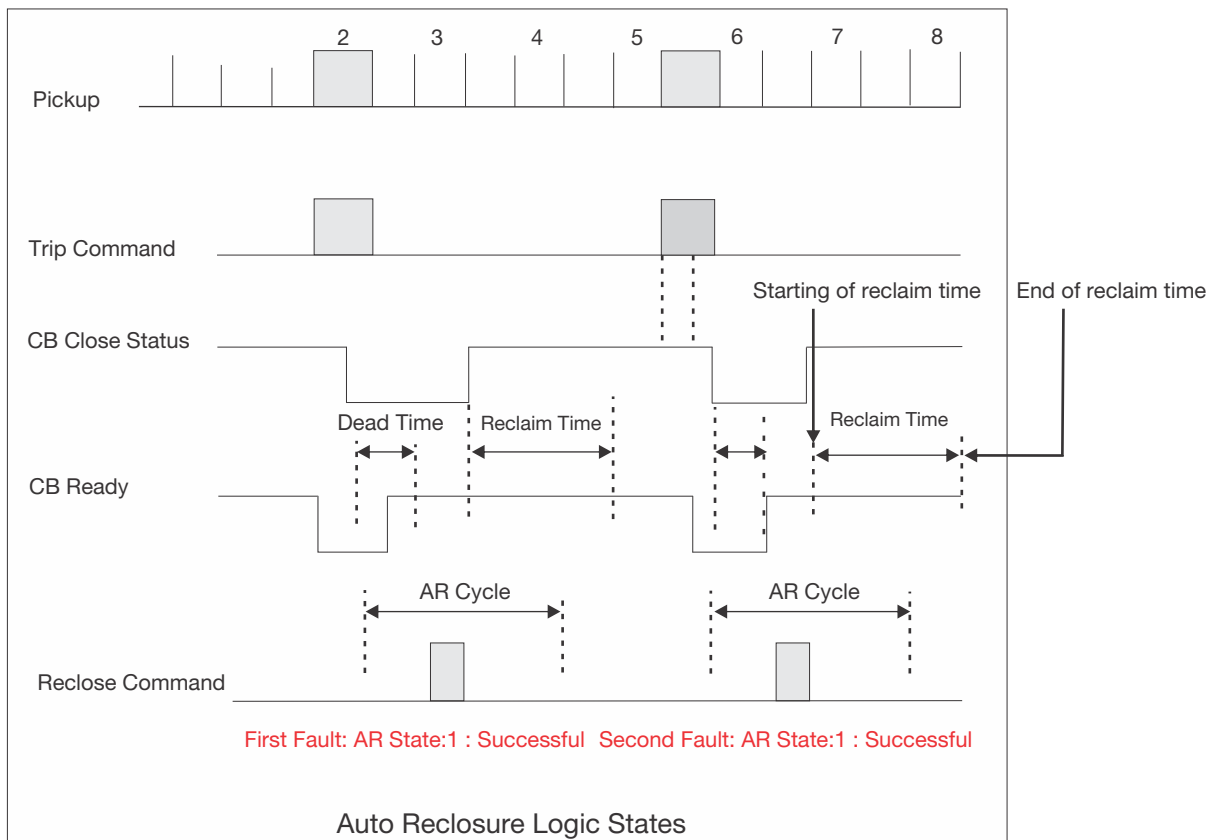

(Figure-2)

## 7) Fault Recording

CSENX-I records last 10 faults in its non volatile memory with its time stamp. Each record has the following information:

Fault Format

[F]IL1 : 00.00A  
 [F]IL2 : 00.00A  
 [F]IL3 : 00.00A  
 [F]Ie : 00.00A  
 HOUR MIN : HH:MM  
 SEC mSEC : Sec:mSec  
 F-TYPE : FAULT TYPE

Where

[F][ILx] Magnitude of phase current's.

[F]Ie Magnitude earth fault current's

F-Type Origin of fault (over current, negative phase sequence, etc.)(See Figure 3)

whenever the available memory space is exhausted the new fault automatically over writes the oldest fault. When the relay trips the description of fault in the feeder will appears on the LCD screen automatically and by pressing "i"key one can easily get all the detailed information of that fault.

The user can view the fault record either via the front USB interface software or remotely via the RS-485 communication.(See figure-3)

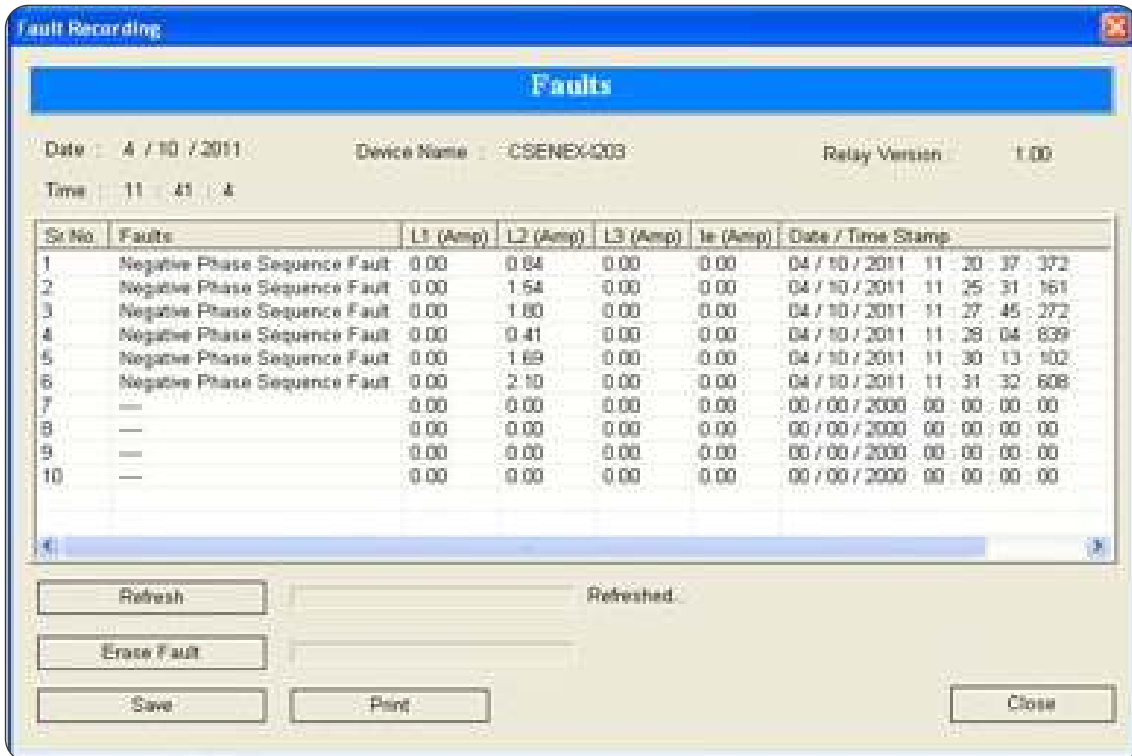

The screenshot shows a software window titled "Fault Recording" with a sub-header "Faults". It displays the following information:

- Date: 4 / 10 / 2011
- Device Name: CSENX-003
- Relay Version: 1.00
- Time: 11 : 41 : 4

Sr.No	Faults	L1 (Amp)	L2 (Amp)	L3 (Amp)	Ie (Amp)	Date / Time Stamp
1	Negative Phase Sequence Fault	0.00	0.04	0.00	0.00	04 / 10 / 2011 11 : 20 : 37 : 372
2	Negative Phase Sequence Fault	0.00	1.54	0.00	0.00	04 / 10 / 2011 11 : 25 : 31 : 161
3	Negative Phase Sequence Fault	0.00	1.80	0.00	0.00	04 / 10 / 2011 11 : 27 : 45 : 272
4	Negative Phase Sequence Fault	0.00	0.41	0.00	0.00	04 / 10 / 2011 11 : 28 : 04 : 839
5	Negative Phase Sequence Fault	0.00	1.69	0.00	0.00	04 / 10 / 2011 11 : 30 : 13 : 102
6	Negative Phase Sequence Fault	0.00	2.10	0.00	0.00	04 / 10 / 2011 11 : 31 : 32 : 608
7	---	0.00	0.00	0.00	0.00	00 / 00 / 2000 00 : 00 : 00 : 00
8	---	0.00	0.00	0.00	0.00	00 / 00 / 2000 00 : 00 : 00 : 00
9	---	0.00	0.00	0.00	0.00	00 / 00 / 2000 00 : 00 : 00 : 00
10	---	0.00	0.00	0.00	0.00	00 / 00 / 2000 00 : 00 : 00 : 00

At the bottom of the window, there are buttons for "Refresh", "Erase Fault", "Save", "Print", and "Close". A "Refreshed:" label is also present.

(Figure-3) (Fault Data Recording on PC Software)

## 8) Event Recording

The unit stores in non volatile memory the last 50 events. When the available memory space is exhausted, the new event automatically overwrites the oldest event which can be retrieved from a PC, with the following format:

EVENT : EVENT NUMBER  
 HOUR : HH:MM  
 SEC mSEC : SEC:mSEC  
 DATE : DD/MM/YY  
 E-TYPE : TYPE OF EVENT

- ❖ Date and time of the event
- ❖ Descriptive text of the even

The user can view event records via the front USB interface software (See Figure 4)

\*Description of event number available in event list or in front end software



The screenshot shows a software window titled 'Event Recording' with a sub-header 'Events'. It displays the following information:

- Date: 4 / 10 / 2011
- Time: 11 : 43 : 0
- Location of Current Events: 39
- Device Name: CSENEX-003
- Relay Version: 1.00

The main data is presented in a table with the following columns: Sr.No, Event Category, Event, Date/Time Stamp, and Priority Index.

Sr.No	Event Category	Event	Date/Time Stamp	Priority Index
1	Trip	DO Trip Due To Negative Phase Seq.	04/10/2011 11:24:00:321	72
2	Protection	DropUp Due To Negative Phase Sequ	04/10/2011 11:24:08:207	131
3	Protection	Pickup Due To Negative Phase Sequ	04/10/2011 11:24:11:100	130
4	Trip	DO Trip Due To Negative Phase Seq.	04/10/2011 11:24:11:242	72
5	Protection	DropUp Due To Negative Phase Sequ	04/10/2011 11:24:24:170	131
6	Protection	Pickup Due To Negative Phase Sequ	04/10/2011 11:24:30:195	130
7	Trip	DO Trip Due To Negative Phase Seq.	04/10/2011 11:24:30:335	72
8	Protection	DropUp Due To Negative Phase Sequ	04/10/2011 11:24:35:309	131
9	Protection	Pickup Due To Negative Phase Sequ	04/10/2011 11:24:42:695	130
10	Trip	DO Trip Due To Negative Phase Seq.	04/10/2011 11:24:42:836	72
11	Protection	DropUp Due To Negative Phase Sequ	04/10/2011 11:24:52:970	131

At the bottom of the window, there are several control buttons: Refresh, Event Erase, Save, Print, Category Selection (dropdown menu), Show, and Close.

(Figure-4) (Event Data Recording on PC Software)



### Output Contacts

No. of digital outputs	:	4 (DO1, DO2, DO3, DO4) [2 Change over (DO1, DO2), 2 Normal open (DO3, DO4)]
Type of outputs	:	Relay
Programmable (DO Assignment)	:	Yes
Relay reset type	:	Programmable (Auto/Manual)





### Input Contacts

No of digital inputs	:	6 (DI1, DI2, DI3, DI4, DI5, DI6)
Programmable (DI Assignment)	:	Programmable

## 9) Human Machine Interface

It comprises of bright LCD display

- ❖ Four push switches for setting values of normal tripping characteristics and other operations for local access.
- ❖ One 'RESET' push switch.
- ❖ Eight LEDs for pickup or tripping on fault and event in any phase.

Keys	Manual Key
	is used as intelligent key to see the details of last fault and Relay status.
	is used as a "ENTER" key.
	is used to manual reset (after pressing for 3 sec).
	is used as Downward scrolling / Decrement key.
	is used as Upward scrolling / Increment key.

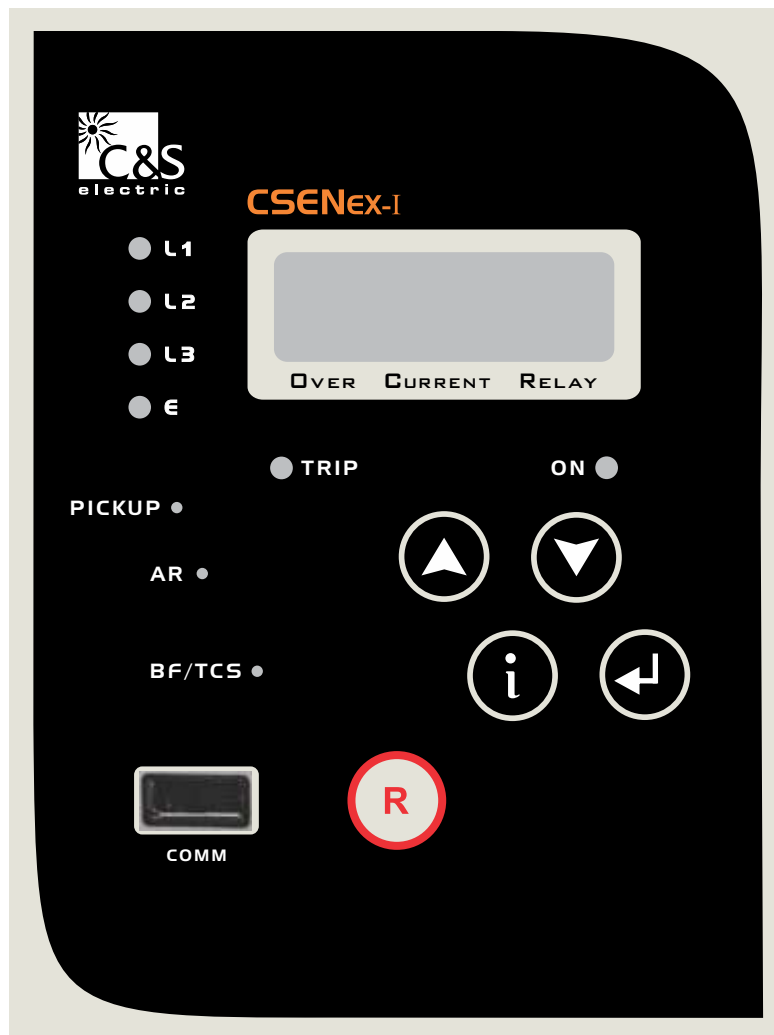

(Figure 5) (HMI)

## 10) Communication (Local and Remote)

The unit has:

- ❖ 1 Front USB port for direct connection to a PC
- ❖ 1 Rear RS-485 communication port

### 10.1) Rear Communication

The protocol for the rear port is MODBUS-RTU.

### 10.2) Front Communication

The entire setting, Fault & Event are available on 'A' type USB (female) interface with CSE LIVELINK with saving & printing option. This unit also has Front-end Live Link simulation support for testing of relay even without any three phase injection source.

## 11) Setting Ranges

### CSENE-X-I Setting Over Current and Earth Protection

S. No	Parameter	Display	Setting Range		Step Size	Default Setting
			Min.	Max.		
1	Phase characteristics	P-Char			DEFT/EINV/VINV /LINV/NINV1.3/ NINV3.0/NINV0.6	DEFT
2	Earth Characteristics	E-Char			DEFT/EINV/VINV /LINV/NINV1.3/ NINV3.0/NINV0.6	DEFT
3	Phase over-current low set pickup setting	I>	0.20xI <sub>p</sub>	4.0xI <sub>p</sub>	0.01xI <sub>p</sub>	EXIT
	Phase over-current definite timing	t>	0.05 Sec	150 Sec	0.01Sec	0.10 Sec
	Phase over-current inverse timing	ti>	0.01	1.50	0.005	0.05
4	Phase over-current hi-set pickup setting	I>>	0.5xI <sub>p</sub>	30xI <sub>p</sub>	0.1xI <sub>p</sub>	EXIT
	Phase over-current hi-set definite timing	t>>	0.02 Sec	20 Sec	0.01Sec	0.10 Sec
5	Earth over-current low set pickup setting	Ie>	0.05xI <sub>n</sub>	2.5xI <sub>n</sub>	0.01xI <sub>n</sub>	EXIT
	Earth over-current low set definite timing	te>	0.03 Sec	150 Sec	0.01Sec	0.10 Sec
	Earth over-current low set inverse timing	tie>	0.01	1.50	0.005	0.05
6	Earth over-current hi-set pickup setting	Ie>>	0.5xI <sub>n</sub>	8xI <sub>n</sub>	0.05xI <sub>n</sub>	EXIT
	Earth over-current hi-set definite timing	te>>	0.02 Sec	20 Sec	0.01 Sec	0.10 Sec

$$\text{Very Inverse} \quad t = \frac{13.5}{(I/I_s) - 1} \quad t_i [s]$$

$$\text{Extremely Inverse} \quad t = \frac{80}{(I/I_s)^2 - 1} \quad t_i [s]$$

$$\text{Long time Inverse} \quad t = \frac{120}{(I/I_s) - 1} \quad t_i [s]$$

$$\text{Normal Inverse 3.0/1.3/0.6} \quad t = \frac{0.14/0.061/0.028}{(I/I_s)^{0.02} - 1} \quad t_i [s]$$

Where  $t$  = Tripping time  $t_i$  = Time multiplier  
 $I$  = Fault current  $I_s$  = Setting value of current

Trip timing Accuracy : DEFT/ NINV 0.6 / NINV 3.0 / 1.3 : +5% OR +30mSec (whichever is higher)  
 EINV / VINV / LINV : +7.5% OR +30mSec (whichever is higher)

## Trip Circuit Supervision Protection

S.No.	Parameter	Display	Setting Range		Step Size	Default Setting
			Min.	Max.		
1	Enable TCS	Enable	NO	YES	-----	NO
2	TCS	t_TCS	0.05 Sec	2 Sec	0.01	0.05 Sec

**Note: t\_TCS max setting is 5 Sec for 203 model**

## Circuit Breaker Failure Protection

S.No.	Parameter	Display	Setting Range		Step Size	Default Setting
			Min.	Max.		
1	Enable CBFP	Enable	NO	YES	-----	NO
2	CBFP	t_CBFP	0.05 Sec	2 Sec	0.01	0.05 Sec

**Note: t\_CBFP max setting is 5 Sec for 203 model**

## Negative Phase Sequence Setting

S.No.	Parameter	Display	Setting Range		Step Size	Default Setting
			Min.	Max.		
1	Enable NPS	Enable	NO	YES	-----	YES
2	NPS characteristics	Char	DEFT	NPS-INV	-----	DEFT
3	Pick up current	lb	0.10xlp	2.5xlp	0.01xlp	0.10xlp
4	Time multiple	K1	5.0	600	1.0	5 Sec
5	Definite time	td	0.10	600	0.10	0.20 Sec

## Negative Phase Sequence Equation

$$t = \frac{K1}{(I_2 / I_b)^2 - 1}$$

Where  $I_2$  is injected NPS current.

Trip timing accuracy: +7.5% OR +30mSec (whichever is higher)

## Broken Conductor Setting

S.No.	Parameter	Display	Setting Range		Step Size	Default Setting
			Min.	Max.		
1	Enable broken conductor	Enable	NO	YES	-----	NO
2	NPS-PPS Ratio	I <sub>2</sub> /I <sub>1</sub>	0.10	0.50	0.01	0.10
3	Definite trip time	tcon	0.05 Sec	20 Sec	0.01 Sec	0.05 Sec

## Harmonic Setting

S.No.	Parameter	Display	Setting Range		Step Size	Default Setting
			Min.	Max.		
1	Enable Phase block	PH Block	NO	YES	-----	NO
2	Phase Blocking time	tPHASE	0.0 Sec	20 Sec	0.1	0.0 Sec
3	Enable Earth block	E Block	NO	YES	-----	NO
4	Earth Blocking time	tEARTH	0.0 Sec	20 Sec	0.1	0.0 Sec

## DI Blocking

S.No.	Parameter	Display	Setting Range		Size	Step Default Setting
			Min.	Max.		
1	Phase over-current low set	I>	Unblock	Block	-----	Unblock
2	Phase over-current hi-set	I>>	Unblock	Block	-----	Unblock
3	Earth over-current low set	Ie>	Unblock	Block	-----	Unblock
4	Earth over-current hi-set	Ie>>	Unblock	Block	-----	Unblock
5	Negative Phase sequence	I <sub>2</sub> >	Unblock	Block	-----	Unblock
6	Broken conductor	BC	Unblock	Block	-----	Unblock
7	Auto Re-closer	AR	Unblock	Block	-----	Unblock

## DI Assignment

S.No.	Parameter	Display
1	Digital Input 1	DI-1
2	Digital Input 2	DI-2
3	Digital Input 3	DI-3
4	Digital Input 4	DI-4
5	Digital Input 5	DI-5
6	Digital Input 6	DI-6

## Following functions can be assigned to the 6 DIs

S.No.	I-203 Configurable
1	CB Close
2	CB Open
3	CB Ready
4	AR Block
5	Remote Trip 1
6	Remote Trip 2
7	Remote Trip 3
8	Protection Block
9	Remote Reset

## DO Assignment \*

S.No	Parameter	Display	Setting Range		Step Size	Default Setting
			Min.	Max.		
1	Phase over-current low set	I>	---	---	DO1/DO2/DO3/DO4	---
2	Phase over-current hi-set	I>>	---	---	DO1/DO2/DO3/DO4	---
3	Earth over-current low set	Ie>	---	---	DO1/DO2/DO3/DO4	---
4	Earth over-current hi-set	Ie>>	---	---	DO1/DO2/DO3/DO4	---
5	Self supervision	SELF SUP	---	---	DO1/DO2/DO3/DO4	---
6	Circuit breaker failure protection	CBFP	---	---	DO1/DO2/DO3/DO4	---
7	Negative phase sequence	I2>	---	---	DO1/DO2/DO3/DO4	---
8	Broken conductor	Broken cond	---	---	DO1/DO2/DO3/DO4	---
9	Trip circuit supervision	TCS	---	---	DO1/DO2/DO3/DO4	---
10	Circuit breaker open	CB_Open	---	---	DO1/DO2/DO3/DO4	---
11	Circuit breaker close	CB_Close	---	---	DO1/DO2/DO3/DO4	---
12	Auto Re-closer Relay	AR Close	---	---	DO1/DO2/DO3/DO4	---
13	Lockout relay	AR Lockout	---	---	DO1/DO2/DO3/DO4	---

## Function Reset \*

S.No.	Parameter	Display	Setting Range		Step Size	Default Setting
			Min.	Max.		
1	Phase over-current low set	I>	Auto	Manual	-----	Auto
2	Phase over-current hi set	I>>	Auto	Manual	-----	Auto
3	Earth over-current low set	Ie>	Auto	Manual	-----	Auto
4	Earth over-current hi set	Ie>>	Auto	Manual	-----	Auto
5	Negative phase sequence	I2>	Auto	Manual	-----	Auto
6	Broken conductor	BC	Auto	Manual	-----	Auto
7	Auto recloser	AR	Auto	Manual	-----	Auto

## Auto Re-closer Mode \*

S.No.	Parameter	Display	Setting Range		Step Size	Default Setting
			Min.	Max.		
1	Enable Auto-recloser	Enable	Yes	No		Yes
2	Dead time 1	D1	0.20 Sec	300 Sec	0.01 Sec	0.20 Sec
3	Dead time 2	D2	0.20 Sec	300 Sec	0.01 Sec	0.20 Sec
4	Dead time 3	D3	0.20 Sec	300 Sec	0.01 Sec	0.20 Sec
5	Dead time 4	D4	0.20 Sec	300 Sec	0.01 Sec	0.20 Sec
6	Reclaim time	tR	0.20 Sec	300 Sec	0.01 Sec	0.20 Sec
7	Phase over-current low set max AR cycle	I>cycle	2	4	1	2
8	Phase over-current hi-set max AR cycle	I>>cycle	2	4	1	2
9	Earth over-current low set max AR cycle	Ie>cycle	2	4	1	2
10	Earth over-current hi-set max AR cycle	Ie>>cycle	2	4	1	2
11	Trip sense time	t_TST	0.05 Sec	2 Sec	0.01 Sec	0.05 Sec

**Note: t\_TST max setting is 5 Sec for 203 model**

## Key Assignment

S.No.	Parameter	Display	Setting Range		Step Size	Default Setting
			Min.	Max.		
1	Function key	F1	----	----	DO1/DO2/DO3 DO4/Relay Reset	DO1

## Neutral Displacement Setting

S.No.	Parameter	Display	Setting Range		Step Size	Default Setting
			Min.	Max.		
1	Enable neutral displacement	Enable	NO	YES	—	NO
2	Neutral Voltage	Vn	2V	50V	1V	7V

## General Setting: (These are the settings common for all protections)

S.No.	Parameter	Display	Setting Range		Step Size	Default Setting
			Min.	Max.		
1	Rated phase current	Ip	1.00 Amp	5.00 Amp	-----	1.00 Amp
2	Rated earth current	In	1.00 Amp	5.00 Amp	-----	1.00 Amp
3	Phase CT ratio	PCTRATIO	1	7000	1	1
4	Earth CT ratio	ECTRATIO	1	7000	1	1
5	Nominal frequency	RATDFREQ	50 Hz	60 Hz	-----	50 Hz

## Rear port communication setting

(\*Availability as per Model Selection)

RS-485 Communication		
Protocol	:	MODBUS RTU
Baud rate selection (programmable)	:	4800/9600/19200/38400/57600bps
Parity selection (programmable)	:	Even / Odd / None
Stop bit	:	1 Bit
Data bit	:	8 Bit data
Remote Address (programmable)	:	(1 to 247)
Cable required for interface	:	Two wire twisted shielded cable

USB Communication		
Protocol	:	CSE proprietary protocol: available with front software
Baud rate	:	19200 bps
Cable required for interface	:	USB cable type (A to A)

### Auxiliary Supply

Auxiliary Voltage Range	For 'L' Model	18V-60V DC
	For 'H' Model	85V-280V AC / 110V-300V DC
Supply Range for Digital Input	For 'L & H' Model	Above 24V AC/DC
Power Consumption		Quiescent approx. 3W Operating approx. <7W

### Measurement Accuracy

S.No	Quantity	Range	Frequency Range	Accuracy
1	Current	1 - 30 xI <sub>p</sub>	50 - 60 Hz	±2%
2	Voltage	5 - 40V	50 - 60 Hz	±2%

### Pickup Accuracy

S.No	Quantity	Range	Frequency Range	Accuracy
1	Current	1 - 30 xI <sub>p</sub>	50 - 60 Hz	+5% of Pickup setting
2	Voltage	5 - 40V	50 - 60 Hz	+6% of Pickup setting

## 12) Technical Data

### Measuring Inputs

Rated Data	Rated current I <sub>p</sub> : 1A or 5A Rated frequency F <sub>n</sub> : 50 Hz/60Hz
Drop out to Pickup Ratio	>96%
Power consumption in current circuit	At I <sub>p</sub> =1A 0.2 VA At I <sub>p</sub> =5A 0.4 VA
Thermal withstand capability in current circuit	Dynamic current withstand (half wave): 250 x I <sub>p</sub> for 1 Sec : 100 x I <sub>p</sub> for 10 Sec : 30 x I <sub>p</sub> continuously : 4 x I <sub>p</sub>



## Relay Contact Rating

<b>Contact Rating</b>	
Contact relay	Dry contact Ag Ni
Make current	Max. 30A & carry for 3S
Carry capacity	8A continuous : Relay 1
	4A continuous : Relay 2, 3, 4
Rated voltage	250V AC/ 30V DC
<b>Breaking Characteristics</b>	
Breaking capacity AC	1500VA resistive
	1500VA inductive (PF=0.5)
Breaking capacity DC	220V AC, 5A ( $\cos\phi \leq 0.6$ )
	135V DC, 0.3A (L/R=30ms)
	250V DC, 50W resistive or 25W inductive (L/R=40ms)
Operation time	<10ms
<b>Durability</b>	
Loaded contact	30000 operation minimum
Unloaded contact	10000 operation minimum

Over-voltage category : II  
 Insulation voltage : 300V  
 Pollution Degree : 2  
 IP 54 from Front

## 13) Type Test

<b>DESIGN STANDARD</b>	
Specified ambient setvice temp. range	: VDE 04355 part 303, IEC 255-4, BS 142
For storage	: 400C to + 850C
For operation	: -200C to 700C
Environmental protection class 'F' as per DIN 40040 and per DIN IEC 68, part 2.3	: relative humidity 95% at 400C for 56 days.
Isolation test voltage, inputs and outputs between themselves and to the relay frame as per VDE 0435, part 303	: 2.5 KV (eff.0 / 50 Hz, 1 min.
Impulse test voltage, inputs and outputs between themselves and to the relay frame as per VDE IEC 0435, part 303	: 5 KV, 1.2/50 $\mu$ s, 0.5
High frequency interference test voltage, inputs and outputs between themselves and to the relay frame as per DIN IEC 255, part 22-1	: 2.5 KV/1MHz
Electrical fast transient (burst) test as per DIN VDE 0843 part 4	: 4KV / 2.5 kHz, 15ms
Radio interference suppression test as per DIN VDE 57 871	: Limit value class 'B'
Electrostatic discharge (ESD) test as per DIN VDE 0843 part 2	: 8 KV
Radiated electromagnetic field test as per VDE 0843 part2	: 10 V/m

## 14) Technical Test

Shock	:	As per DIN IEC 41 B (CO) 38: class 1
Vibration	:	As per DIN IEC 41 B (CO) 35: class 1
Protection-Front Panel	:	IP 54
Protection-Rear Panel	:	IP 00
Weight	:	Approx. 1.0 Kg

## 15) Model Selection Table

Function	ANSI	NEX-I 203
CT inputs	–	4
PT inputs	–	1
Over current	50/51	✓
Earth Fault	50N/51N	✓
Neutral displacement	59N	✓
CBFP	50BF	✓
Unbalance	46	✓
Trip circuit	74TC	✓
Inrush blocking	51H	✓
Broken conductor	46BC	✓
Auto Re-closer	79	✓
Digital input	–	6
Digital output	–	4
Fault record	–	10
Event record	–	50
Selection of 1/5A	–	Site selectable
Enclosure type	–	Draw out with CT shorting
Enclosure size (WxHxD)	–	(112x152x153)mm
Front communication	–	✓
Rear comm. (RS-485)	–	✓

## 16) Connection Diagram

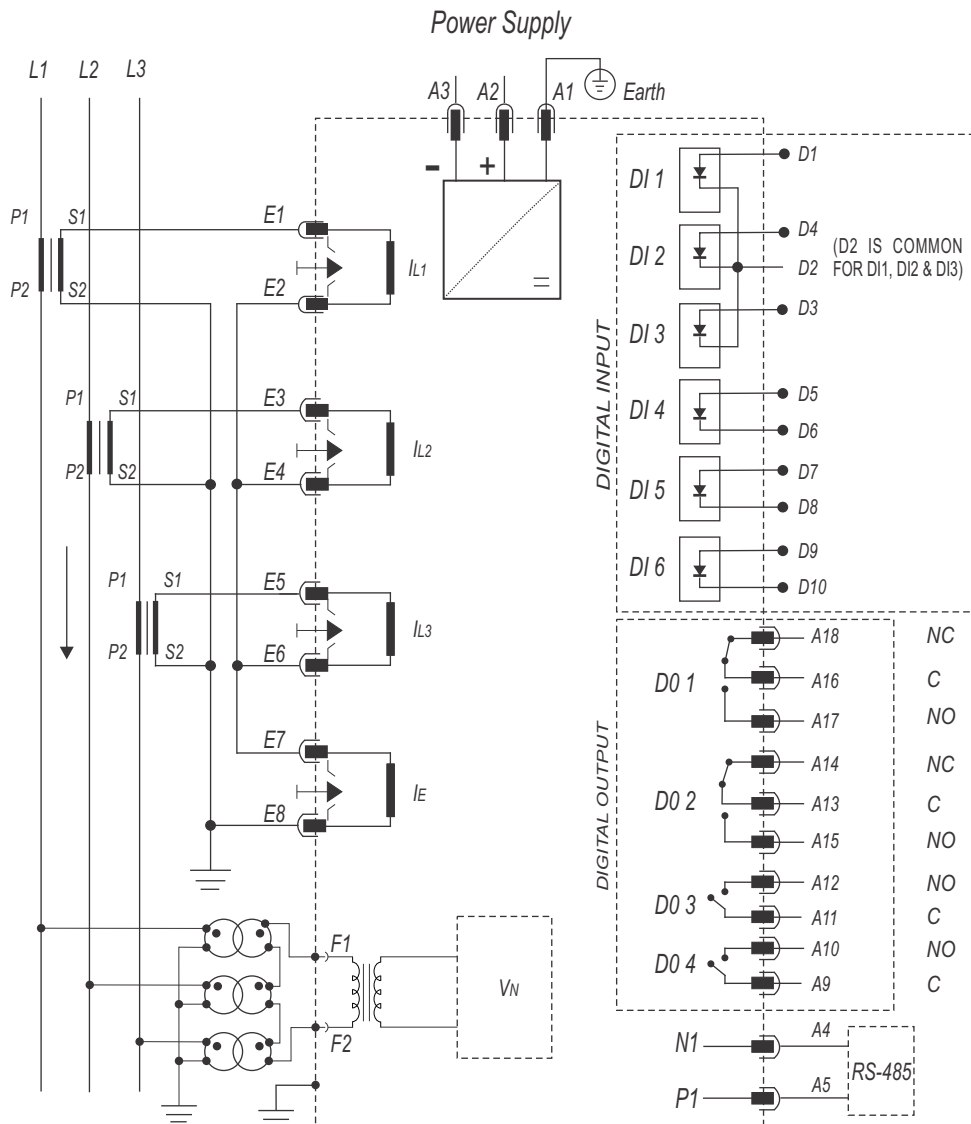

(Figure-6)

### Terminal Description

Terminal Name	Terminal Description
A1	: Auxiliary Supply Earth
A2-A3	: Auxiliary Supply
A4-A5	: RS-485 Modbus N1(A4), P1(A5)
A9-A10	: Potential free Digital Output 4
A11-A12	: Potential free Digital Output 3
A13-A14-A15	: Potential free Digital Output 2
A16 -A17- A18	: Potential free Digital Output 1
D1-D2	: Potential Digital Input 1
D4-D2	: Potential Digital Input 2
D3-D2	: Potential Digital Input 3
D5-D6	: Potential Digital Input 4
D7-D8	: Potential Digital Input 5
D9-D10	: Potential Digital Input 6
E1-E6	: CT Terminal for Phase current input L1(E1-E2), L2(E3-E4),L3(E5-E6)
E7-E8	: CT Terminal for Earth current input
F1-F2	: PT Terminals

## Trip Circuit Supervision

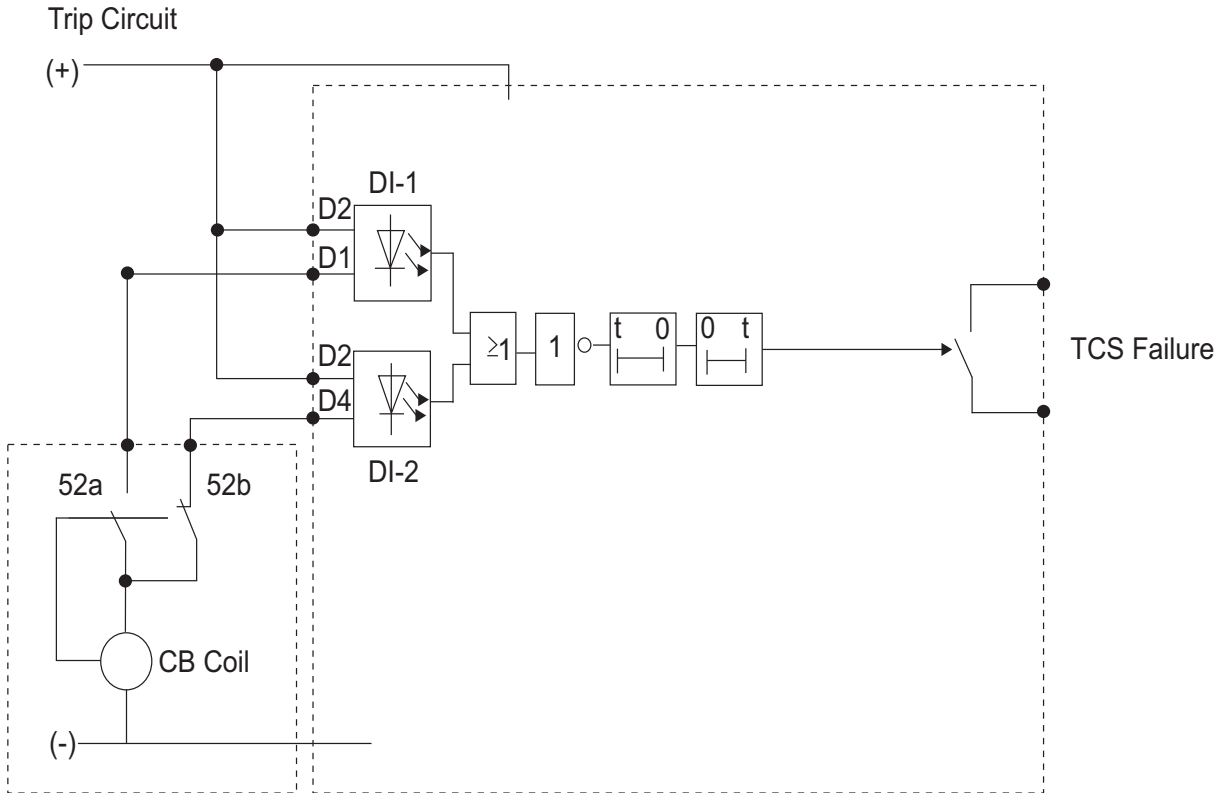

(Figure-7)

(Note: CB coil resistance should be such that at least 4mA current must flow in each Digital Input)

## 17) Back Terminal Diagram

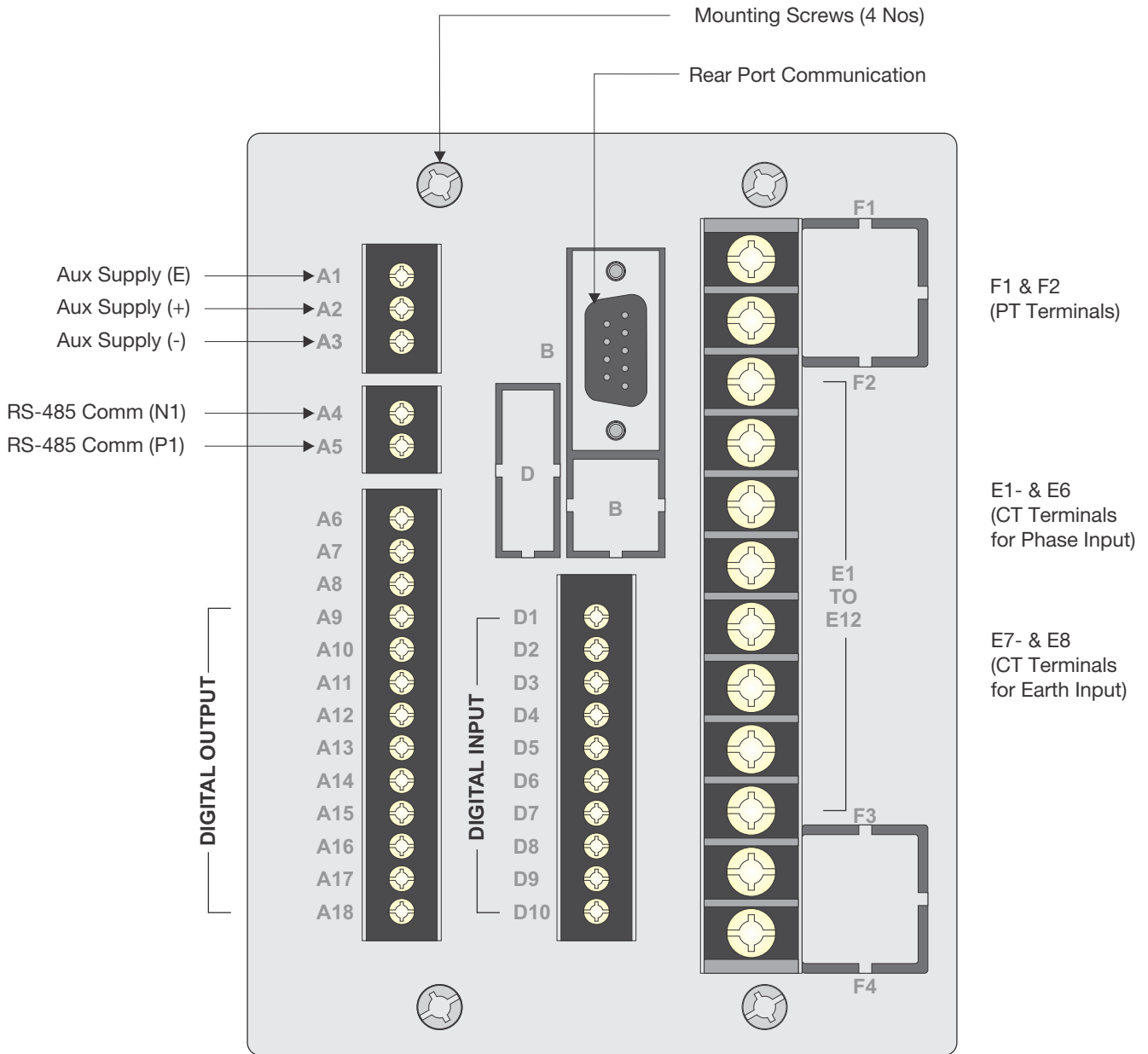

(Figure-8)

## 18) Dimensional Details

Front View

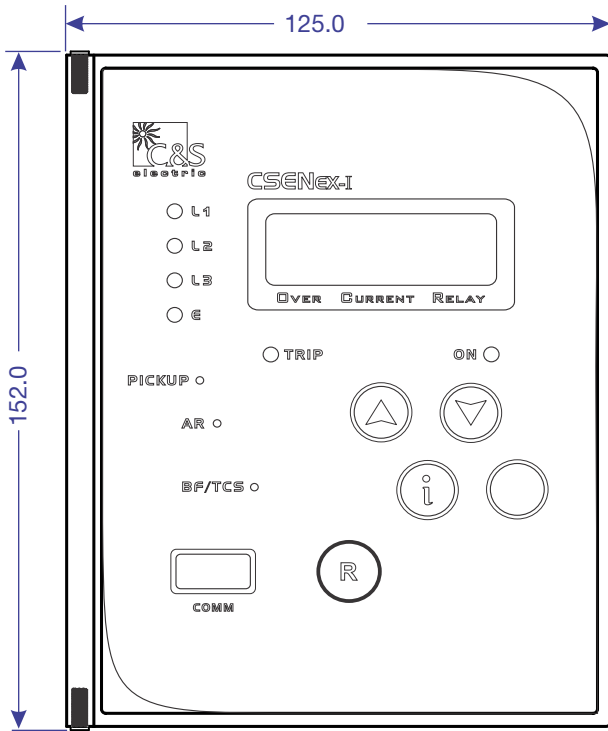

(Figure-9)

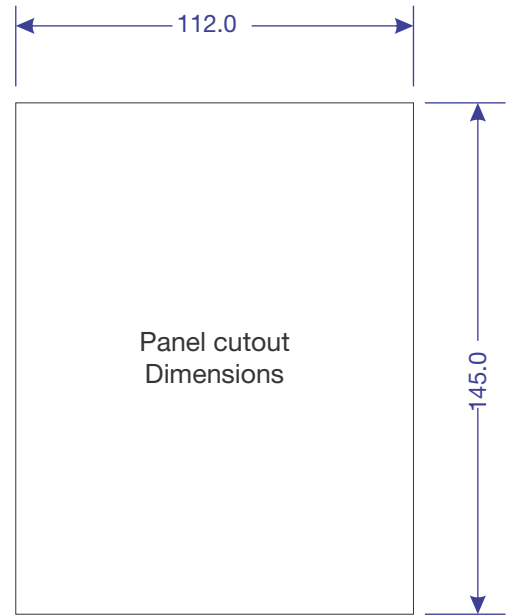

(Figure-10)

Side View

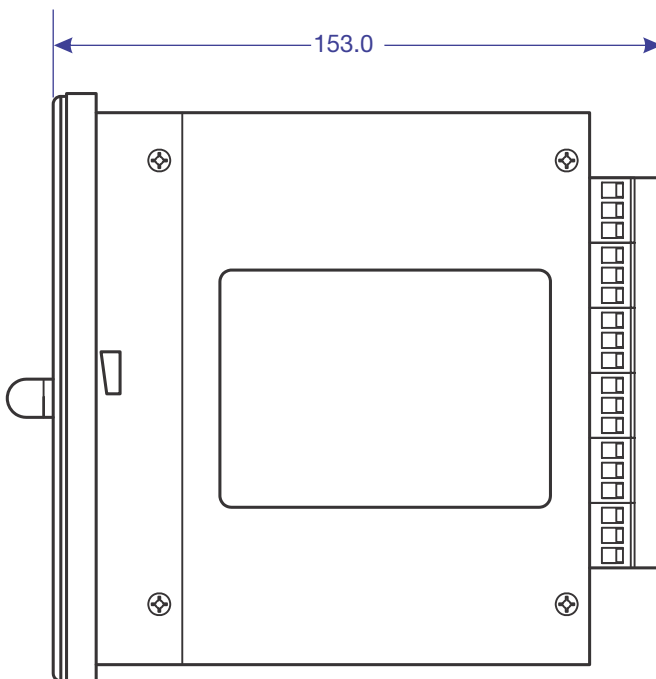

(Figure-11)

## 19) Ordering Information

